

CITADEL[®] 2.0 SERIES

FOR TIMELESS PROTECTION

NBS

15kV-63kA-Draw-out Citadel[®] Vacuum Breaker



Installation, operations and maintenance manual



15kV-63kA-4000A Citadel® Fixed Mounted Vacuum Breaker



15kV-63kA-4000A Citadel® Draw-Out Vacuum Breaker and Cell



CITADEL[®] 2.0 SERIES

FOR TIMELESS PROTECTION

Citadel[®] Available Ratings

Narrow Fixed and Draw-Out VCB Elements				
Voltage Class	CTDL Model # - kA FX DO	Available Amperage	Width Fixed Element	Width Draw-Out Element
5 kV	50 -CTDL-31.5 - FX DO	1200-2000	19.6"	22.125"
5 kV	50 -CTDL-40.0 - FX DO	1200-2000	19.6"	22.125"
7.5kV	75 -CTDL-40.0 - FX DO	1200-2000	19.6"	22.125"
15 kV	150-CTDL-20.0 - FX DO	1200-2000	19.6"	22.125"
15 kV	150-CTDL-31.5 - FX DO	1200-2000	19.6"	22.125"
15 kV	150-CTDL-40.0 - FX DO	1200-2000	19.6"	22.125"
• Numerical value at end of CTDL Model # reference kA value				

26" wide Switchgear

Regular Fixed and Draw-Out VCB Elements				
Voltage Class	CTDL Model # FX DO	Available Amperage	Width Fixed Element	Width Draw-Out Element
5 kV	50 -CTDL-50.0 - FX DO	1200-2000-3000	28.375	32.313
5 kV	50 -CTDL-63.0 - FX DO	1200-2000-3000	28.375	32.313
5 kV	50 -CTDL-63.0 - FX DO	4000	28.375	32.313
7.5kV	75 -CTDL-40.0 - FX DO	1200-2000-3000	28.375	32.313
15 kV	150-CTDL-50.0 - FX DO	1200-2000-3000	28.375	32.313
15 kV	150-CTDL-63.0 - FX DO	1200-2000-3000	28.375	32.313
15 kV	150-CTDL-63.0 - FX DO	4000	28.375	32.313

50kA + 63kA rating is 36 inches wide switchgear
 3000 | 4000 Amp - 36 inches wide switchgear

36" wide Switchgear

S A F E T Y P R A C T I C E S

DANGER



This instruction manual applies to fixed mounted and draw out Citadel vacuum circuit breaker elements regarding installation and maintenance procedures.

Installing and / or maintaining these products in an improper manner may result in serious injury, property damage, or death. Therefore this instruction manual must be read and understood in all aspects of unpacking, assembly, operation, and maintenance of the breaker, and its associated assembly.

Medium Voltage circuit breakers and switchgear are inherently dangerous and potentially deadly.

Large mechanical forces are stored in; and discharged by the mechanism.

Operating and control voltages can severely burn, flash, damage and kill.

Medium Voltage circuit breakers and some switchgear component are heavy and can be unwieldy. Items of these sizes and weight can cause serious injury and death if moving / falling and striking an individual.

Damage and Death or serious injury can be the results of untrained operators, improper operation.

Always discharge, de-energize and ground the equipment before attempting any maintenance.

Only trained, knowledgeable, skilled individuals should attempt to maintain and operate medium voltage breakers and switchgear.

NEVER use parts that are not new and original equipment from the original equipment supplier.

It is highly recommended that factory trained personnel are employed to perform work and or oversee site maintenance personnel until they attain a level of proficiency.

Qualified person

Qualified persons have read the instruction manuals for the circuit breaker and switchgear thoroughly. They have engage factory experts to explain and augment areas not fully understood.

This / These person(s) should be trained, skilled and have full access to all Proper Protective Equipment associated with medium voltage electrical devices including but not limited to – hard hat, safety glasses (with prescriptions as necessary) face shield – fire retardant coveralls – arc flash suiting, insulated gloves and safety shoes as mandated and in accordance with good practices.

Qualified persons should understand proper practices for de-energizing, grounding and LOTO (lock out tag out) in accordance with well-established good practices.

Operations and maintenance practices should be well thought out in advance and documented. Persons approaching this equipment should have a monitoring individual accessible at a distance and first aid equipment immediately on hand.

This manual provides general and informative knowledge of the breaker and switchgear. This manual is NOT exhaustive nor detailed enough to cover every application and event.

It is the SOLE obligation of those individuals using and overseeing operation and maintenance of this equipment to recognize their obligation to reach out to the factory to provide more in-depth assistance.

The equipment supplier reserves the right to make changes, improvements and specifications alterations to its equipment and procedures at any time without specific notice or other obligation.

Under NO circumstances should this manual be considered able to **cover every event, detail or variation in equipment or configuration.**

Operations and Maintenance personnel **MUST** be provided with and **maintain an appropriate level of knowledge and proficiency to interact with this equipment. Anything less should mandate employing properly trained factory authorized individuals.**

Nothing in this document implies or attempts in any way to alter or modify the sales agreement, contract terms, warranty or long term operation and maintenance obligations of the owner / using entities(s).

TABLE OF CONTENTS

Safety Practices	5-6
Table of Contents	7
Introduction	8-10
Ratings Table and weights	11-12
Receiving, Handling and Storage	13-14
Initial Checks and Functional Testing	15-21
Spring Charge / Discharge	22
General Dimensions	23-26
Vacuum Interrupter	28-37
General Construction	38-39
Citadel Controls	40-51
Switchgear Cubicle & Draw-out Features	52-87
Breaker Operation	88-99
Close & Trip Take-off Extension Rods	100
Positive “Block the Close” Interlock	101
Masta - Main Armature Switch Take-off Assembly	102-103
Nameplate	104-105
Maintenance	106-128
Lubrication	129-147
Sequential Operation Diagram	148
Troubleshooting Guide	149
Wiring Diagram	150-151
Spare Parts List	152-155
Tools List	156
Contact Us	Back cover

INTRODUCTION

DANGER The safety and health of our customers is our paramount focus and concern. The following will be repeated regularly throughout this document.



Medium Voltage circuit breakers and switchgear are inherently dangerous and potentially deadly.

Large mechanical forces are stored in and discharged by the mechanism. Operating and control voltages can severely burn, flash, damage and kill. Damage and Death, or serious injury, can be the results of untrained, improper operation.

ONLY TRAINED, EXPERIENCED, QUALIFIED individuals should attempt to install, operate, maintain or in other ways interact within arm's length of medium voltage circuit breakers and switchgear.

The Citadel vacuum circuit breaker element is designed to meet the applicable ANSI, NEMA and IEEE standards.

Application, operation and long life of this equipment depends upon good and proper installation as well as proper maintenance by the user.

This instruction manual is meant to assist clients in learning, training and developing safe and effective procedures for the installation, maintenance and operations of this equipment.

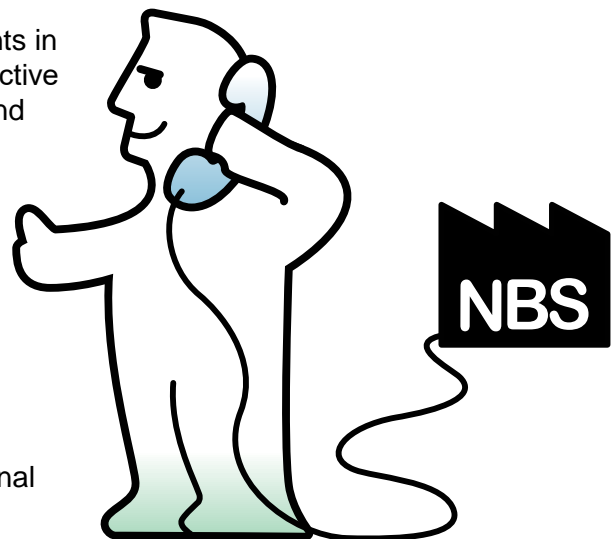

Never guess!

ALWAYS Contact the factory as additional information is desired/needed.

ALERT WORDS

“Alert Words” are used to draw additional attention to the information presented and note the presence of peril.

DANGER



Very hazardous situation which must be immediately avoided, or can result in death or serious injury.

WARNING



Potentially hazardous situation which should be avoided to avert death or serious injury.

CAUTION



Potentially hazardous situation which, if not avoided, might result in moderate injury.

CAUTION (without safety alert symbol) - A potentially hazardous situation which can result in property damage.

WARNING



NEVER attempt to override, remove or in any way defeat any interlock functions or interlock devices.

ONLY consider such actions under **VERY thoughtful** consultation with well-trained switchgear users, operations and maintenance experts.

Defeating interlocks **WILL** void all warranties and may result in property damage, injury and **DEATH**.

WARNING



NEVER work on equipment unless it is de-energized and grounded.

ALWAYS de-energize the control voltage and discharge the breaker's mechanism springs before laying hands or tools on the breaker or switchgear devices.

NEVER work on equipment unless you are well trained on it, and working in the proper protective equipment needed for the operational functions you intend to perform.

WARNING



NEVER force breakers!

If racking, sub-assemblies or ANY other parts that are known to operate smoothly under normal conditions are not doing so;

Assume something needs to be fixed – NOT FORCED.

R A T I N G S T A B L E & W E I G H T S

TABLE:1

CIRCUIT BREAKER TYPE	MAXIMUM DESIGN VOLTAGE (V) ¹	VOLTAGE RANGE FACTOR (K) ²	WITHSTAND VOLTAGE LEVELS		CONTINUOUS CURRENT	SHORT-CIRCUIT (I) ^{3,4}	INTERRUPTING TIME ⁵
			POWER FREQUENCY kV RMS	LIGHTNING IMPULSE (BIL) kV CREST			
50-CTDL-31.5	4.76	1.0	19	60	1,200, 2,000, 3,000	31.5	83/5
50-CTDL-40.0	4.76	1.0	19	60	1,200, 2,000, 3,000	40	83/5
50-CTDL-50.0	4.76	1.0	19	60	1,200, 2,000, 3,000	50	83/5
50-CTDL-63.0	4.76	1.0	19	60	1,200, 2,000, 3,000, 4000	63	83/5
75-CTDL-40.0	8.25	1.0	36	95	1,200, 2,000, 3,000	40	83/5
150-CTDL-20.0	15.0	1.0	36	95	1,200, 2,000	20	83/5
150-CTDL-31.5	15.0	1.0	36	95	1,200, 2,000, 3,000	31.5	83/5
150-CTDL-40.0	15.0	1.0	36	95	1,200, 2,000, 3,000	40	83/5
150-CTDL-50.0	15.0	1.0	36	95	1,200, 2,000, 3,000	50	83/5
150-CTDL-63.0	15.0	1.0	36	95	1,200, 2,000, 3,000, 4,000	63	83/5
63KA TO 4000A + 5000A SELF COOLED - CONSULT FACTORY							

Footnotes:

- ANSI/IEEE C37.04-1999 Standard Rating Structure for AC High-Voltage Circuit Breakers
 - ANSI/IEEE C37.06-2009 AC High-Voltage Circuit Breakers Rated on a Symmetrical Current Basis - Preferred Ratings and Related Required Capabilities for Voltages Above 1,000 Volts
 - ANSI/IEEE C37.09-1999 Standard Test Procedure for AC High-Voltage Circuit Breakers Rated on a Symmetrical Current Basis
 - ANSI/IEEE C37.010-1999 Application Guide for AC High-Voltage Circuit Breakers Rated on a Symmetrical Current Basis.
1. Maximum design voltage for which the circuit breaker is designed and the upper limit for operation.
 2. K is listed for information purposes only. For circuit breakers rated on a “constant kA” ratings basis, the voltage range factor is 1.0.
 3. All values apply to polyphase and line-to-line faults.
 4. Standard duty cycle is O - 0.3 s - CO - 3 min. - CO.
 5. Standard rating interrupting time is five-cycles (83 ms). Optional rated interrupting time of three-cycles (50 ms) is available (except with 24 Vdc tripping).

R A T I N G S T A B L E & W E I G H T S

TABLE: 1B

PERMISSIBLE TRIPPING DELAY (Y)	MAX. SYM. INTERRUPTING (I)	% DC COMPONENT	SHORT-TIME CURRENT (I) (3S)	CLOSING AND LATCHING (MOMENTARY)		CIRCUIT BREAKER TYPE
				ASYMMETRICAL (1.55 X I) kA RMS	PEAK (2.6 X I) kA PEAK	
S	KA RMS SYM	%	KA RMS			
2	31.5	47	31.5	49	82	50-CTDL-31.5
2	40	47	40	62	104	50-CTDL-40.0
2	50	47	50	78	130	50-CTDL-50.0
2	63	47	63	98	164	50-CTDL-63.0
2	40	47	40	62	104	75-CTDL-40.0
2	20	47	20	31	52	150-CTDL-20.0
2	31.5	47	31.5	49	82	150-CTDL-31.5
2	40	47	40	62	104	150-CTDL-40.0
2	50	47	50	78	130	150-CTDL-50.0
2	63	47	63	98	164	150-CTDL-63.0

TABLE 2: WEIGHT CHART FOR ALL FIXED VCB AND DRAWOUT VCB

S.no	Description	Weight(KGS)/per VCB	lbs
1	5 - 15.0 KV, 1200A, 31.5 KA FIXED VCB	126	278
2	5 - 15.0 KV ,2000A, 40.0 KA FIXED VCB	139	307
3	5 - 15.0 KV, 1200A, 31.5 KA DRAWOUT VCB	154	338
4	5 - 15.0 KV, 2000A, 40.0 KA DRAWOUT VCB	174	382
5	5 - 15.0 KV, 4000A, 63.0 KA FIXED VCB	270	595
6	27.0 KV, 1200A, 25.0 KA FIXED VCB	127	390

RECEIVING , HANDLING & STORAGE

It is mandatory that the procedures of receiving personnel are to make a physical inspection of the shipping container before removing or unpacking the circuit breaker from the delivery truck and again prior to subsequent moving's.

Check for shipment damage or indications of rough handling by the carrier.

Check each item against the manifest to identify any shortages.

**Inappropriate or untimely reporting
will void corrections being covered under warranty**

It is the responsibility of the receiving person(s) (entities) to fully inspect and accept or report damage. Lack of fulfillment of this responsibility will have commercial impact.

Visible shipping damage must be identified by receiving individual(s) prior to signing the delivery receipt.

Lack of such notifications will allow the Factory to assume damage was done on site and not covered by shipping insurance or warranty claims.

It is essential that notification must be presented to carrier within 15 days for concealed damage.

1. When the shipment arrives, note whether the equipment is properly protected from the elements. Note the trailer number the equipment arrived on.. Note also any blocking of equipment. During unloading, check the actual equipment delivered to verify it agrees with the delivery paperwork.
2. Make immediate inspection for visible damage upon arrival and prior to un-packaging or un-wrapping any material(s). This should be done prior to unloading. When inspection cannot be made on the delivery vehicle prior to unloading, a much closer inspection during unloading must be performed and visible damage clearly noted on the delivery receipt.

ALWAYS Take photos!

3. Get the Trailer number, license plate, drivers name and Phone # in writing and note the date and time of the event.



WARNING

Medium Voltage circuit breakers, switchgear and some switchgear component are heavy and can be unwieldy.

Items of these sizes and weights can cause serious injury and death if moving / falling and striking an individual.

Obtain the services of qualified riggers for hoisting the switchgear and circuit breaker to avoid damage.

Note: Shipments are not released from the NBS factory without a clear bill of lading. Properly developed methods have been employed for preparation, loading, tarping and blocking the equipment in the factory, and on the truck before it leaves the NBS factory. If the equipment is received in a damaged condition, this damage to the equipment must have occurred while on route and beyond NBS' control. Without following procedures as outlined above by the receiving parties, purchaser or their agent, NBS cannot / will not be held liable for repairs. NBS will not be held liable for repairs in any case where repair work was attempted and or performed prior to authorization from NBS.

1. Remove the shipping carton from the circuit breaker carefully. Keep the shipping pallets for later possible storage use prior to installation.
2. Inspect for outward and concealed damage. Notification to carrier must take place within 15 days to assure any claims resolution.
3. Each circuit breaker should be lifted properly. Do not allow any force or crushing of the side panels of the circuit breaker, or damage to the primary disconnect (cluster) assemblies.

Refer to Table 2 (page 12) for circuit breaker weights.

4. Palletized circuit breaker can be moved using a properly rated fork-lift type device.

It is advised that IEEE std C37.20.2 section 9 and Annex are reviewed and incorporated.

Storage

1. Whenever possible, install the circuit breaker in its switchgear enclosure.
2. When the circuit breaker is to be placed on a pallet for storage, securely bolt the breaker to the pallet and cover with strong polyethylene or non-moisture collecting material.

Indoor storage

Store the circuit breaker indoors in a clean, dry environment that is free of construction dust, corrosive atmosphere, mechanical abuse and extensive temperature swings.

Outdoor storage

Outdoor storage is not recommended.

Space heating

Space heating must be used to prevent condensation and corrosion. 150 - 250 watts per circuit breaker of space heating is recommended depending on humidity and temperature swings.

If the circuit breaker is stored inside the switchgear enclosure- energize the space heaters if they are available.

Introduction

Checks and tests to be performed on the circuit breaker module only.

Vacuum circuit breakers are normally shipped with their vacuum interrupter’s primary contacts closed and their mechanism springs discharged. However, it is **CRUCIAL** to first verify the spring-loaded mechanism is in the discharged condition after de-energizing control power for safety and to insure no automatic spring charging can occur.

Discharge the close spring via mechanical front panel push button – then discharge the opening spring via its front panel push button.

De-energizing control power in switchgear

When the circuit breaker is mounted in switchgear, open the control-power disconnect device.

In metal-clad switchgear, the control power disconnect device is normally a pullout-type fuse holder, a molded-case circuit breaker, or knife switch.

Opening this fuse holder, circuit breaker or switch device results in control power disconnection.

Perform the spring-discharge check before moving a circuit breaker from a pallet or removing it from the switchgear.

The spring discharge check should be performed after de-energizing control power. This check assures both the tripping and closing springs are fully discharged.

1. Press Trip pushbutton.
2. Press Close pushbutton.
3. Press Trip pushbutton again.
4. Spring-condition indicator should show - **DISCHARGED**
5. Main contact status indicator should show breaker - **OPEN**

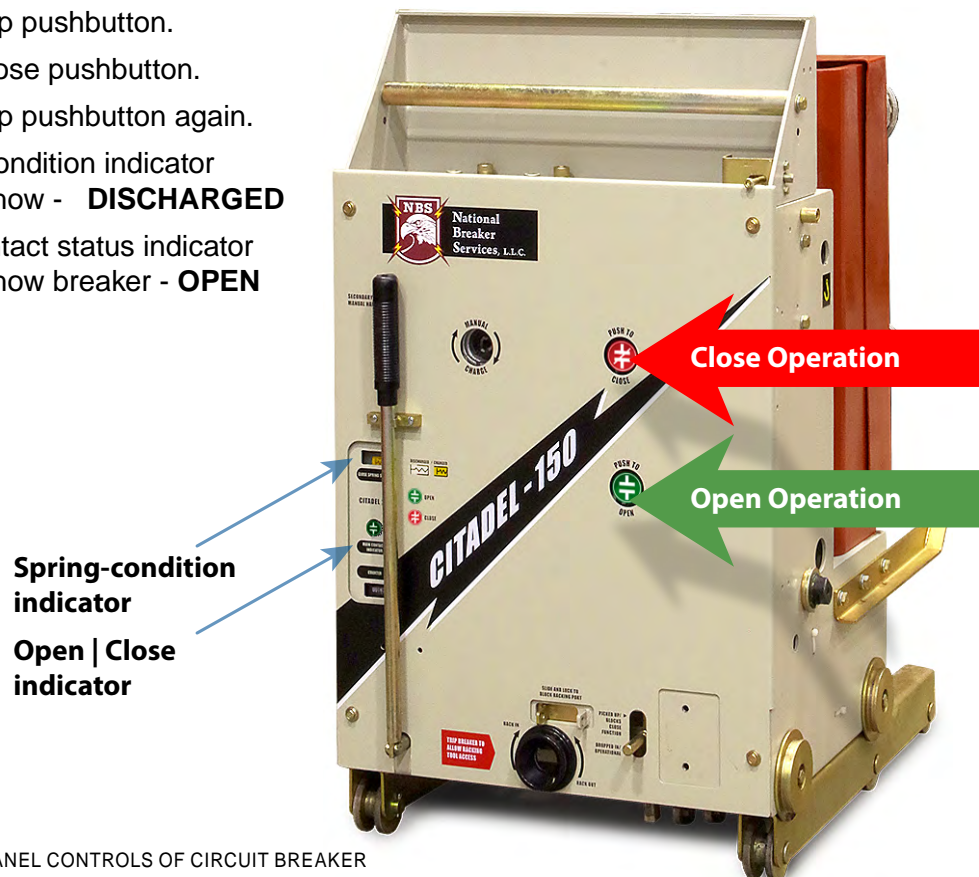



FIGURE 1: FRONT PANEL CONTROLS OF CIRCUIT BREAKER

Note: Do not perform the spring-discharge check if the circuit breaker is in the CONNECT position of a draw out cubicle.

Open the circuit breaker and rack breaker to the DISCONNECT position then perform the spring discharge check.

For fixed-mounted circuit breaker applications, open any isolator switches on the line side and on the load side of the circuit breaker before performing the spring-discharge check.

If no isolators exist – verify primary and control circuits are de-energized prior to spring discharge.

	<p>DANGER Performing a Spring discharge will close the breaker – this is not to be allowed with breaker connected to live primary circuits.</p> <p>High-speed moving parts and hazardous voltage will cause death, serious injury and property damage.</p> <p>Only trained, qualified personnel shall perform any of these functions.</p> <p>Read instruction manuals and observe safety practices.</p>
---	--

Manual-spring charging check

1. Insert the manual-spring charging hand crank into the manual-charging socket (refer to Figure 2B- page 18). Turn the crank clockwise (about 50 turns) until the spring- charge / discharge condition indicator shows the closing spring is - **CHARGED**
2. Repeat the above Spring- Discharge procedure.
3. Verify the springs are **DISCHARGED** and the circuit-breaker primary contacts are noted as – **OPEN** on the front panel indicator.

As-found and vacuum-integrity check tests

Perform and record the results of an as-found insulation test.

Perform and record the results of a vacuum integrity check (dielectric) test.

Procedures for these tests are described in the Maintenance section of this instruction manual.

Save results for future comparisons.

Automatic spring-charging check

The automatic spring-charging features of the circuit breaker must be checked. Control power is required to automatically charge the closing spring.

CAUTION Never Manually Charge a circuit breaker without first removing control power to the motor and the balance of the Citadel Element control circuits.



Charging the Close Springs

When it is desired to charge the Citadel Close spring manually – the high torque of the differential gear box makes manual operation easy.

A simple technique to supplement this manual approach can be achieved by using the end of the breaker’s manual charging tool in a speed regulated cordless drill.

FIGURE 2: MANUAL CHARGING OF CLOSING SPRING



Manually charging the closing spring (refer to Figures 2 and 2B pages 17 , 18)

Insert the hand crank through the front cover opening into the manual charging port. Engage the charging tool into the charging port’s socket. Turn the charging tool clockwise (approx: 50 turns) until the closing-spring indicator displays “CHARGED”.

As the manual charging process starts to pick up the close springs – the operator will feel modest additional mechanical resistance.

As the Spring Charging Arm comes over the top of its stroke and the close spring fully charges – you will hear a distinctive “click” within the mechanism

The breaker element is now Charged and ready to Close.

Manual closing - Press the close button on the Citadel front cover. The CLOSE/ OPEN indicator will display “CLOSED”.

Since the Close Spring has now operated to perform the close function the closing spring indicator will now display “DISCHARGED”.

FIGURE 2B: MANUAL CHARGING OF CLOSING SPRING

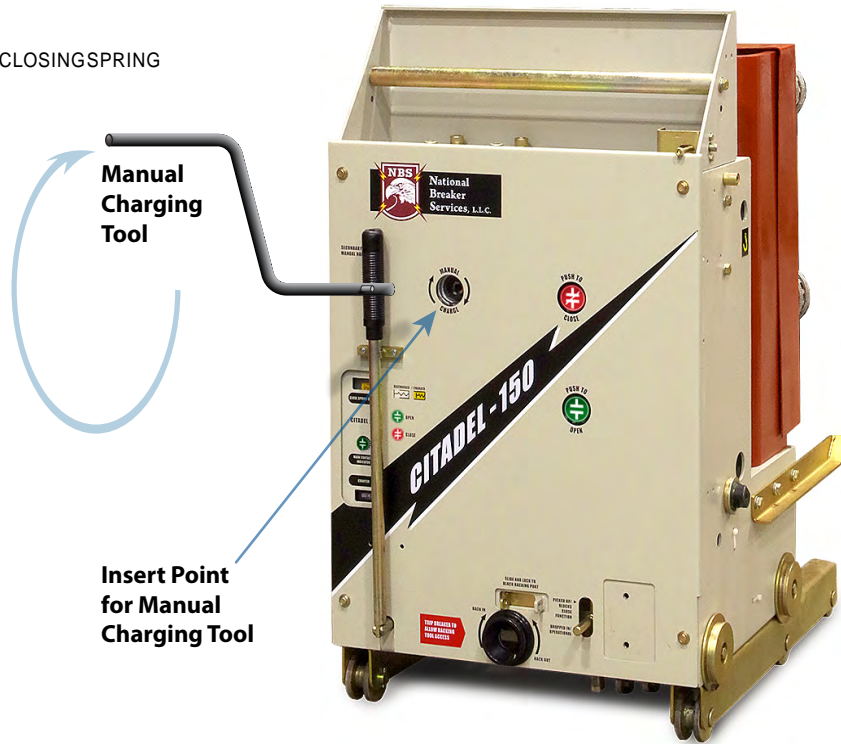

Note: If a temporary source of control power is required – verify control-power source is of the proper voltage per the breakers nameplate or the specifically provided schematic drawings with the breaker and switchgear.

When control power is connected to the circuit breaker, the closing spring will automatically begin to charge.

1. Open control-power circuit by opening the control power disconnect device.
2. Connect control power to proper charging motor pins of secondary or fixed mounted breaker top terminal block
3. Energize (close) the control power circuit disconnect.
4. Use the Close and Open controls (refer to Figure 1 page 15) to first Close and then Open the circuit breaker contacts. Verify contact positions by visually observing the OPEN/ CLOSED indicator on the circuit breaker front panel. Use an ohm-meter to verify contacts are closed electrically and provide dual verification of the front panel indicator.
5. De-energize control power by repeating Step 1 above. If a secondary connector umbilical cord was used for temporary control-power connections, disconnect the umbilical cord from the switchgear first and next from the circuit breaker.
6. Perform the above mentioned spring-discharge check again to verify that the closing spring is discharged and the primary contacts of the circuit breaker vacuum interrupters are open.

Final mechanical inspections without control power

Make a final mechanical inspection of the circuit breaker. Verify the contacts are in the open position and the closing spring is discharged. Check for loose hardware.

Since the closing spring is automatically recharged by the motor operating mechanism when the breaker has closed; the operating mechanism is capable of an open-close-open duty cycle as required for rapid auto-reclosing.

Opening

The tripping spring is charged during closing. To open the breaker, press the trip button until the vacuum breaker has tripped and “OPEN” is displayed by indicator.

Manual Operation

Electrically operated vacuum breakers can be operated manually if the control supply should fail.

Manually Charging the Closing Spring

Insert the hand-crank in hole and turn clockwise until charge spring mechanism “clicks” and indicator shows spring “CHARGED”.

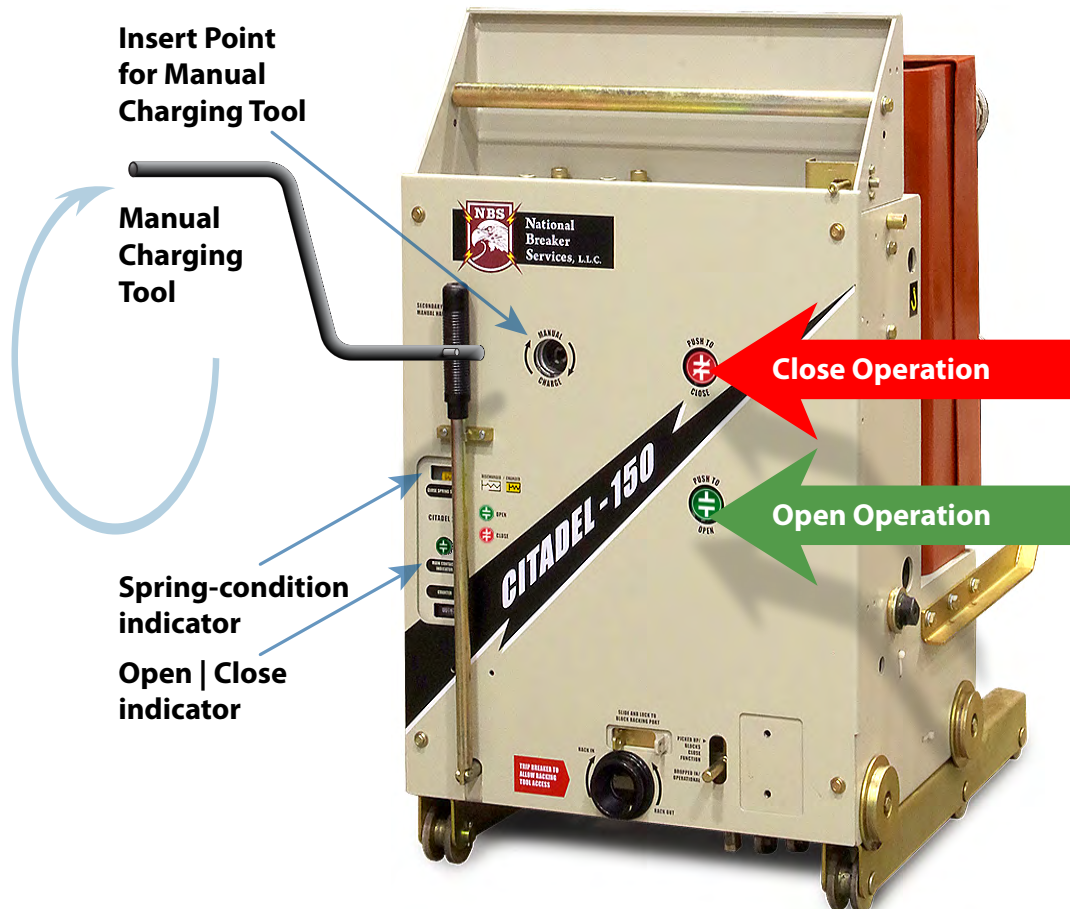

FIGURE: 3

FIGURE 1A:FRONTPANELCONTROLSOFCIRCUITBREAKER

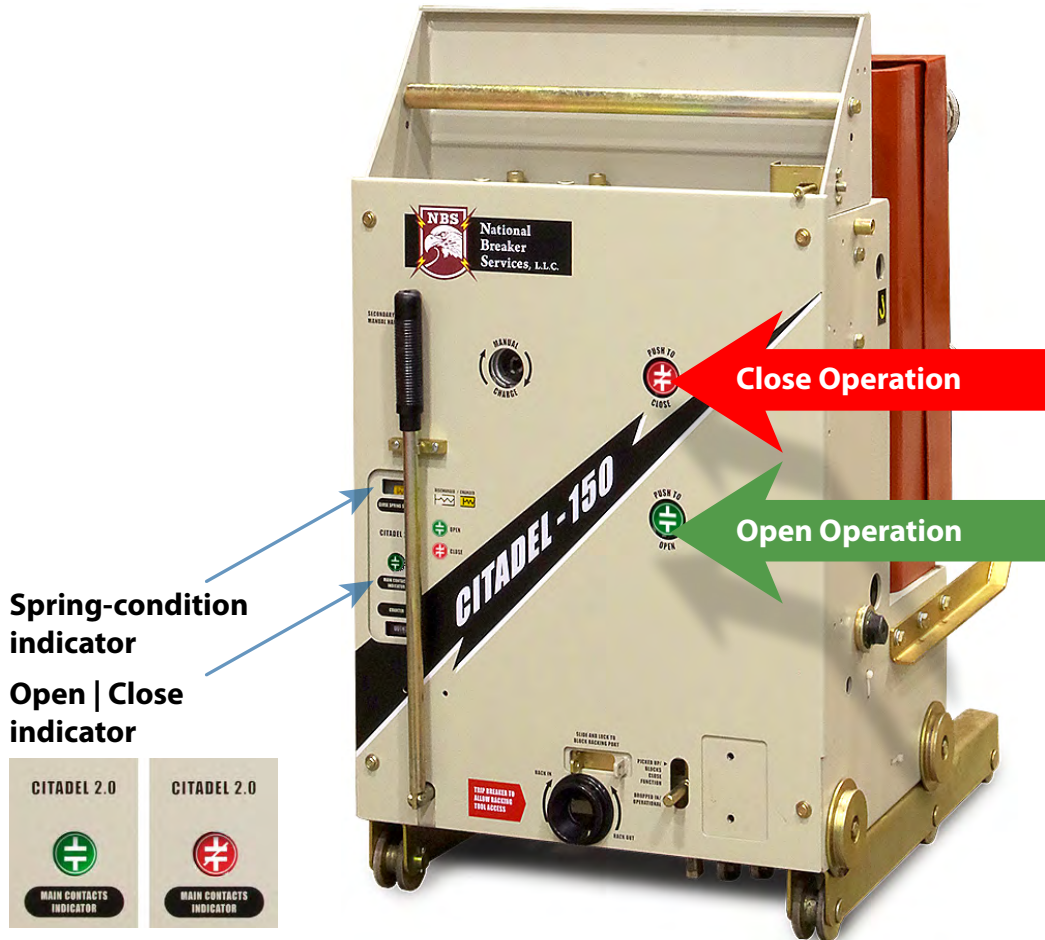

FIGURE 1B

FIGURE 1: FRONT PANEL CONTROLS OF CIRCUIT BREAKER

Manual opening - The opening spring is automatically charged during closing process. To open the circuit breaker, press the Open pushbutton on the Citadel front cover. The CLOSE/ OPEN indicator will display “OPEN”

CAUTION



Disconnect motor control power when attempting manual charging.

In order to avoid injuries as a result of the motor suddenly starting up, the circuit breaker spring must only be charged manually with the special hand crank.

An Optional special hand charging crank which automatically disengages if the spring-charging motor operates can be factory ordered.

Breaker's-indication-panel

On the Citadel front panel near center on left side is an indication panel. This panel provides color coded intuitive symbology for; Breaker Closing-spring condition **charged** (yellow compressed spring) or **discharged** (white decompressed spring) breaker contact position **open** (green contacts separated) or **closed** (red contacts touching and cross hatched) Breaker operations counter (each count equals a full close / open cycle).

FIGURE 4

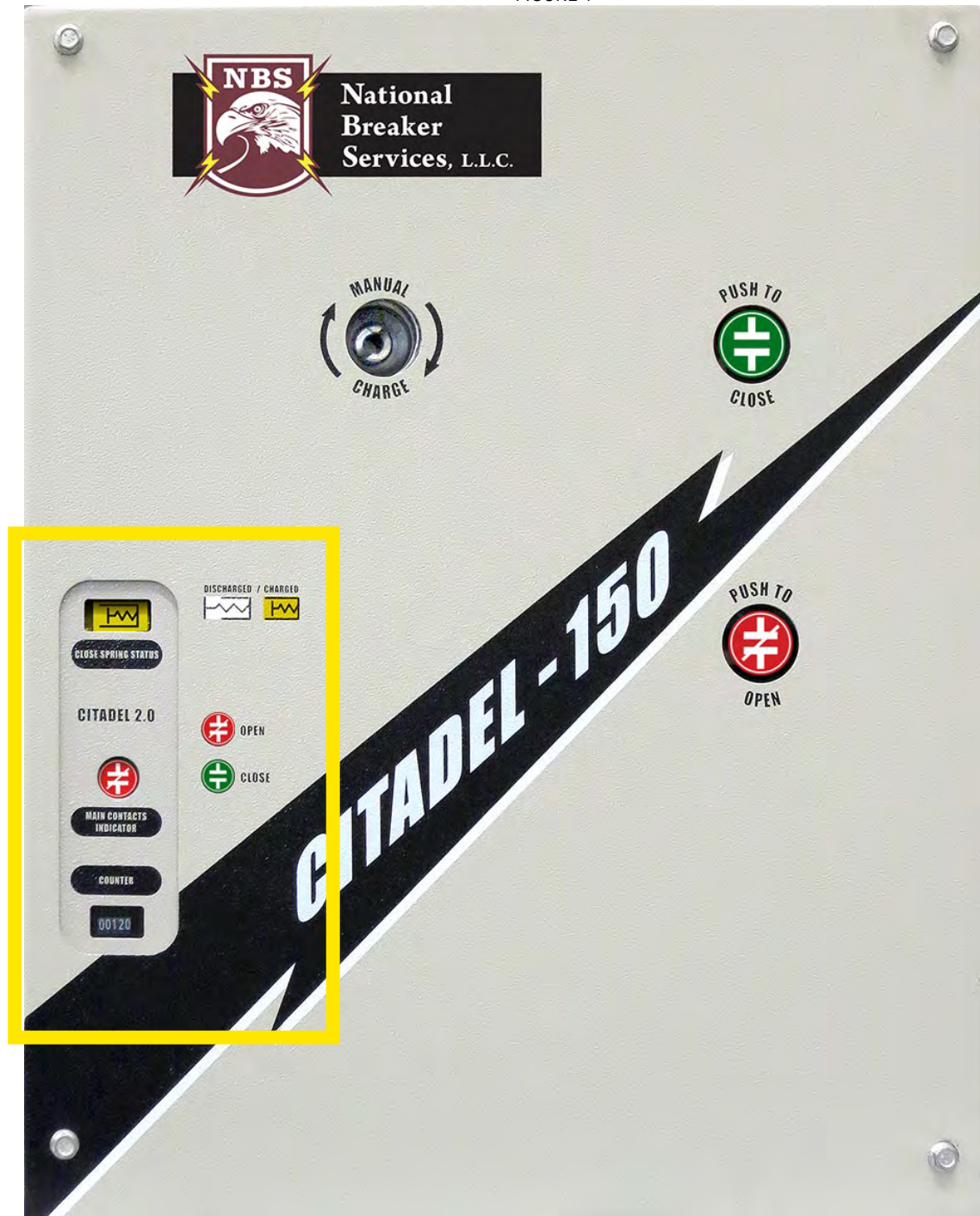

SPRING CHARGE / DISCHARGE

A mechanical flagging assembly is moved by the rotation of the closing spring crank arm. When the closing spring is “CHARGED” the following pictorial is seen in the window located on the lower left portion of the Citadel’s front cover. The window is located immediately above the CLOSE/OPEN indicator.

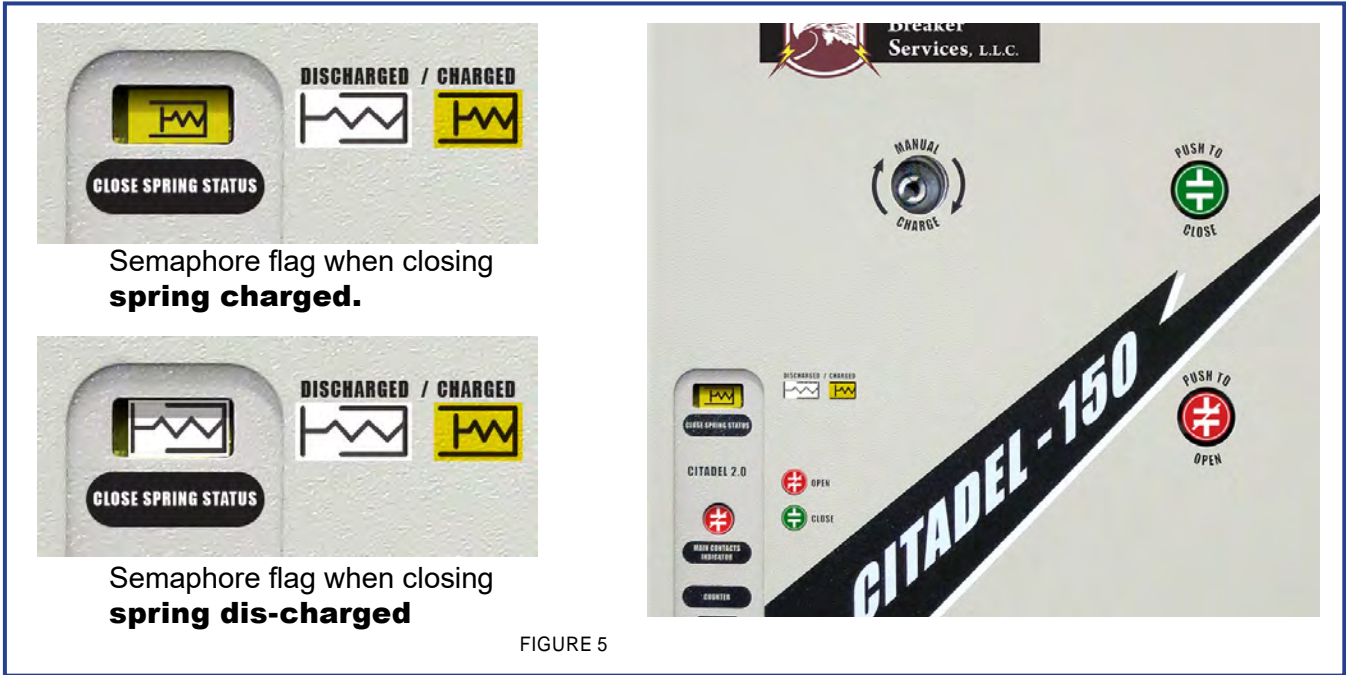

A mechanical flagging assembly is moved by the rotation of the Citadel’s Main Armature Shaft. The indication of “CLOSED” or “OPEN” can be seen on the lower left hand side of the Citadel through a window in the front cover.



Operations Counter

The Citadel element incorporates an operations counter that increments by one for each open / close cycle. The counter is visible in the window just below the open close flag.



GENERAL DIMENSIONS

Breaker dimensions for "6 inch" pole center fixed mounted elements

- 01. MECHANISM ENCLOSURE
- 02. COPPER RUNBACK
- 03. PUSHROD ASSEMBLIES
- 04. VACUUM INTERRUPTER
- 05. COPPER SHUNTS
- 06. VACUUM INTERRUPTER INSULATOR DRIVER

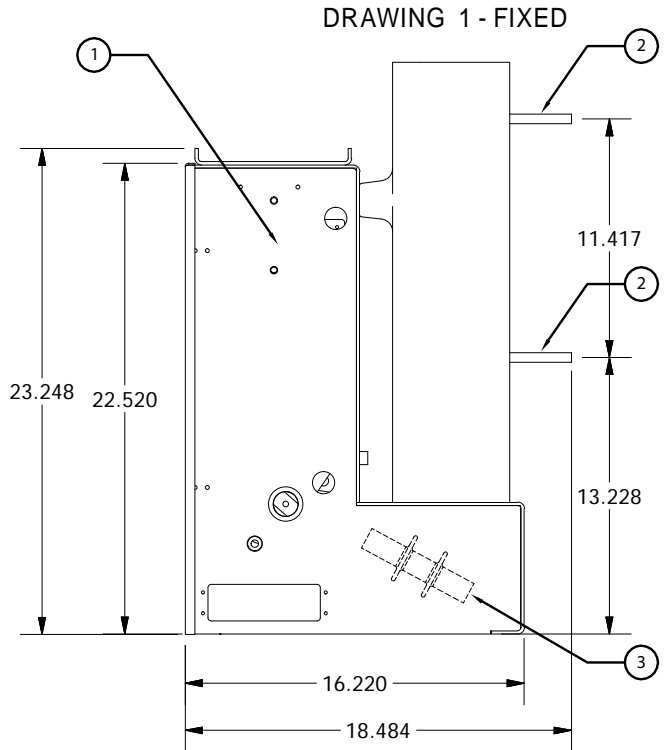

SIDE VIEW

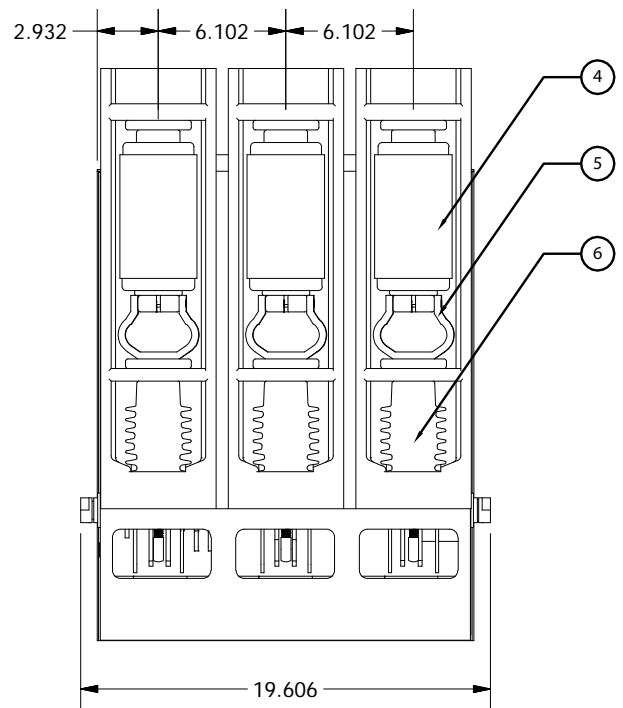
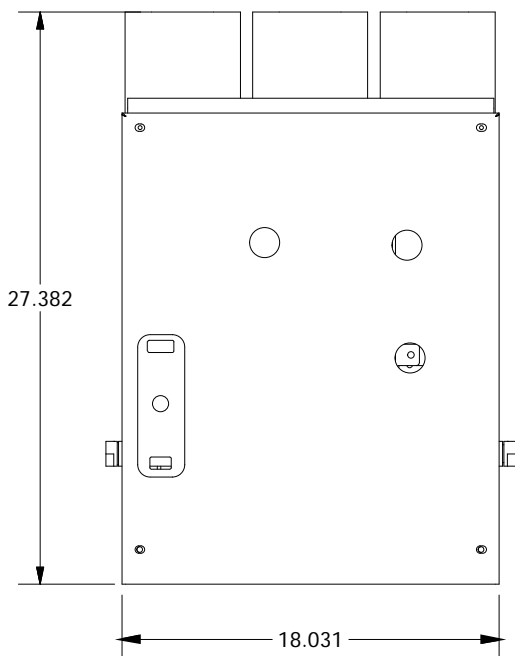

GENERAL DIMENSIONS

Breaker dimensions for 26" wide draw-out switchgear

DRAWING 2 - DRAW-OUT

- 01. MECHANISM ENCLOSURE
- 02. VACUUM INTERRUPTER SUPPORT MOLDING
- 03. COPPER RUNBACK
- 04. MOVING SECONDARY CONTACT BLOCK ASSEMBLY

- 05. MOVABLE SECONDARY HANDLE
- 06. VACUUM INTERRUPTER
- 07. FINGER CLUSTER

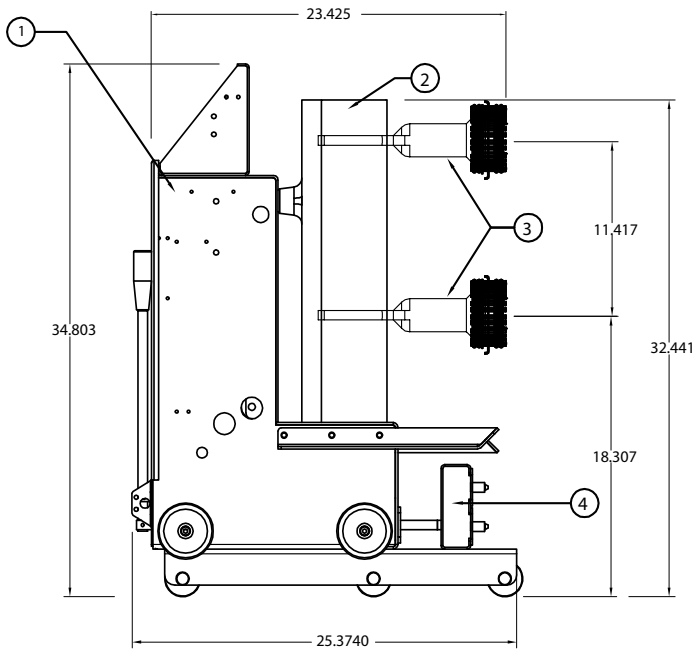

SIDE VIEW

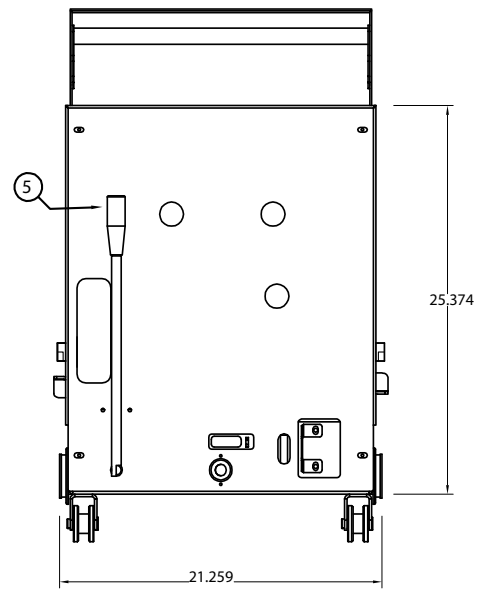

FRONT VIEW

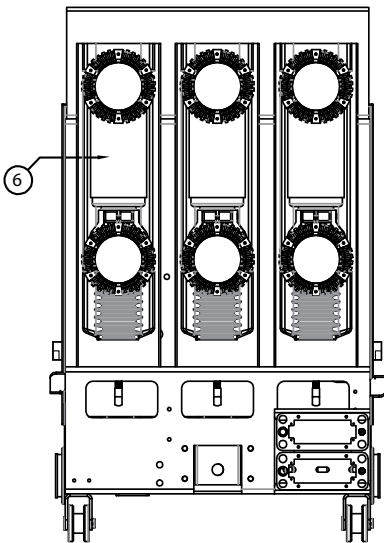

REAR VIEW

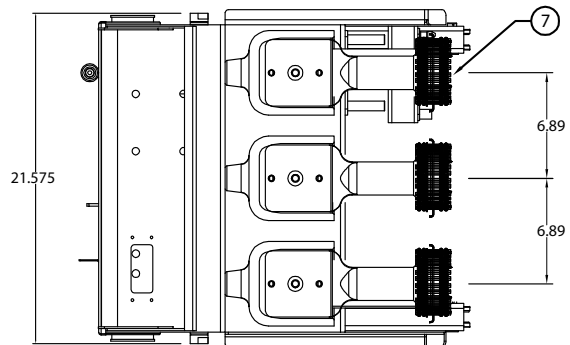

TOP VIEW

GENERAL DIMENSIONS

Breaker dimensions for “10 inch” pole center fixed mounted element

DRAWING 3-FIXEDELEMENT

- | | |
|---------------------------------|--|
| 01. UPPER FLANGE / HEATSINK | 07. FLEXIBLE SHUNT TYPE-1 (OUTER) |
| 02. LOWER FLANGE / HEATSINK | 08. FLEXIBLE SHUNT TYPE-2 (INNER) |
| 03. STAND-OFF SUPPORT INSULATOR | 09. FLEXIBLE SHUNT TYPE-3 (SIDE MOUNT) |
| 04. VACUUM INTERRUPTER | 10. VI MOVING TERMINAL CLAMP |
| 05. VI-INSULATOR STABILIZER ROD | 11. PUSH-ROD ASSEMBLY INSULATOR |
| 06. UPPER PRIMARY CONNECTION | 12. MECHANISM ENCLOSURE |

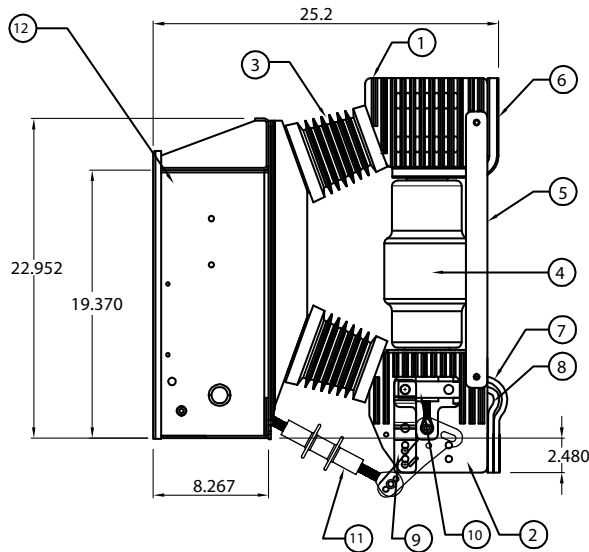

SIDE VIEW

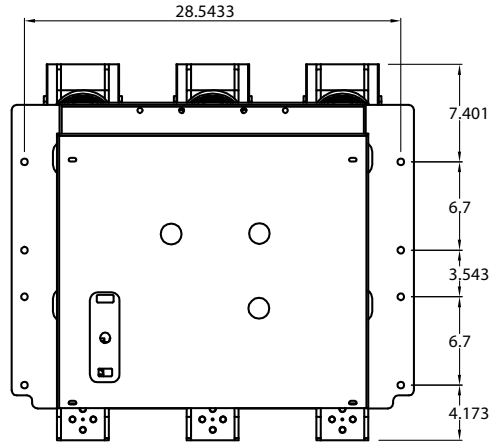

FRONT VIEW

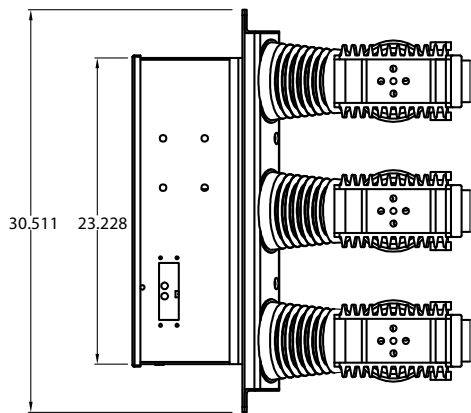

TOP VIEW

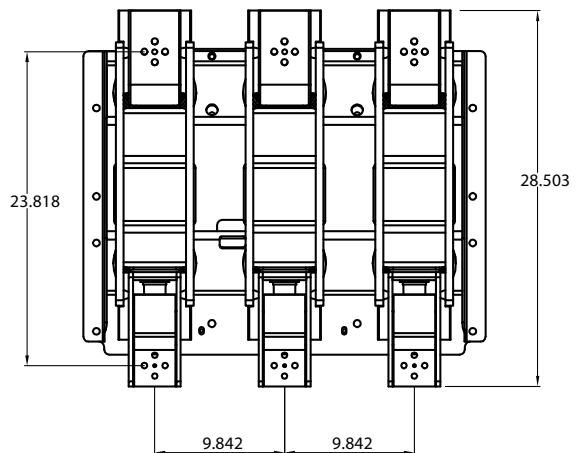

REAR VIEW

**Pole assemblies herein are for breakers from 1200 to 4,000 amp.
For 5,000 amp Citadel Elements see appropriate O&M manual.**

GENERAL DIMENSIONS

Breaker dimensions for 36" wide draw-out switchgear

DRAWING 4 - DRAWOUT

- | | |
|---------------------------------|--|
| 01. UPPER HEAT SINK | 09. LOWER SHUNT #3 (SIDE) |
| 02. LOWER HEAT SINK | 10. VI MOVING TERMINAL CLAMP |
| 03. SUPPORT INSULATOR-EPOXY | 11. VI PUSH ROD INSULATOR |
| 04. VACUUM INTERRUPTER | 12. MECHANISM ENCLOSURE |
| 05. HEAT SINK STABILITY SUPPORT | 13. MOVABLE "FINGER CLUSTER" CONTACT |
| 06. TOP COPPER RUNBACK | 14. MOVABLE "FINGER CLUSTER" CONTACT MOUNTING ASSEMBLY |
| 07. LOWER SHUNT #1 (OUTER) | 15. LOWER COPPER RUNBACK |
| 08. LOWER SHUNT #2 (INNER) | |

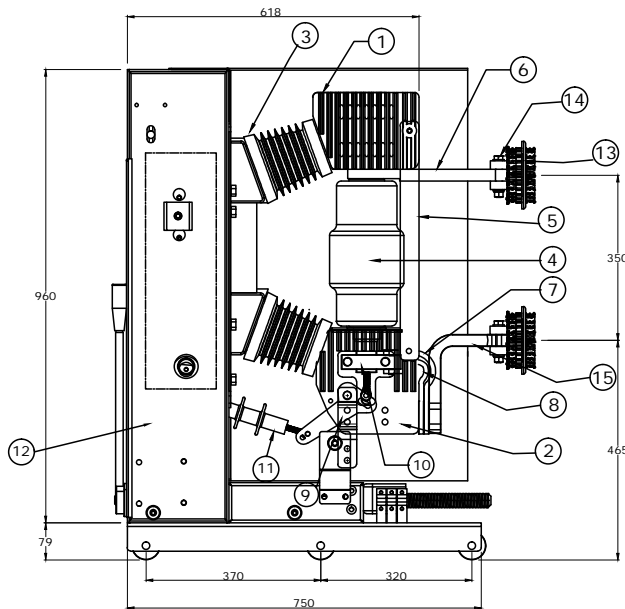

SIDE VIEW

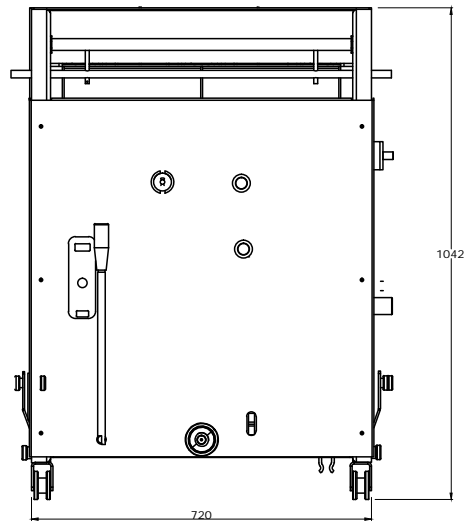

FRONT VIEW

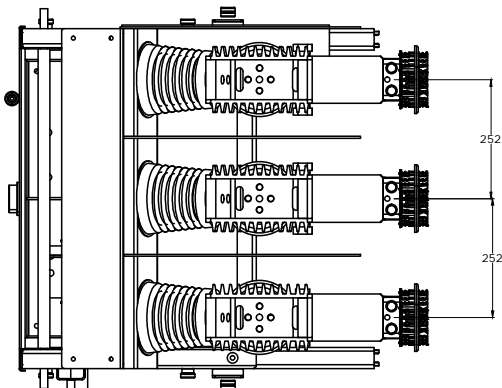

TOP VIEW

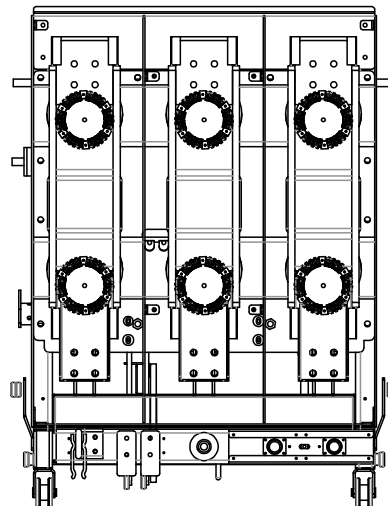

REAR VIEW

The Citadel vacuum circuit breaker performs its closing and opening functions by using three vacuum interrupters connected to a stored-energy operating mechanism. To operate properly and safely, it is necessary to have electrical controls and interlock devices. The Draw-out function is enabled by having disconnect devices to connect the circuit breaker to both primary (finger cluster assemblies) and control (secondary connector) power. The stored energy operating mechanism is housed in its own rugged, electrically grounded metal enclosure located on the front of the breaker.

Depending on voltage class, insulating barriers may be located between the vacuum interrupters and along their outer sides.

This section describes the breaker's major subassembly and is a basic primer tool in the operation, installation, maintenance of the circuit breaker.

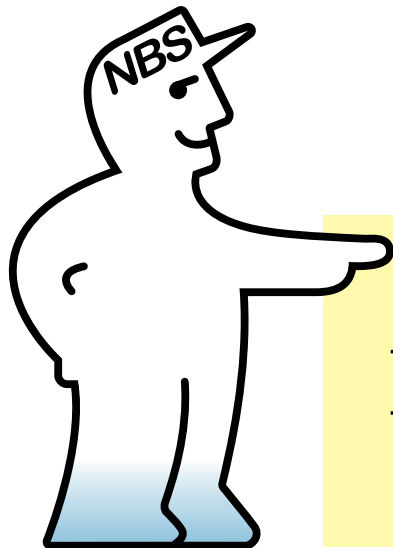

NBS recommends engaging factory trained persons only to perform repair services.

VACUUM INTERRUPTER / OPERATOR

Vacuum interrupters

The vacuum interrupter is a simple device with two internal electrical power conducting contacts. One is secured in place and stationary within the vacuum interrupter assembly. The other contact can move a short distance in and out (approx. 1/2") to electrically make-up or separate the contacts.

A metal bellows (accordion assembly) is welded around the moving contact structure. This permits contact movement while maintaining vacuum inside the interrupter.

The movable contact is connected to the driving mechanism of the circuit breaker via electrically insulated push rod assemblies.

When the two contacts separate inside a vacuum, an arc is initiated that jumps across the contacts and continues conduction up to the next point that the AC current goes through a zero crossing. At this "current zero" crossing the arc extinguishes.

Any metal vapor that has formed by the arcing will now condense back onto the contacts and on the surrounding arc shield.

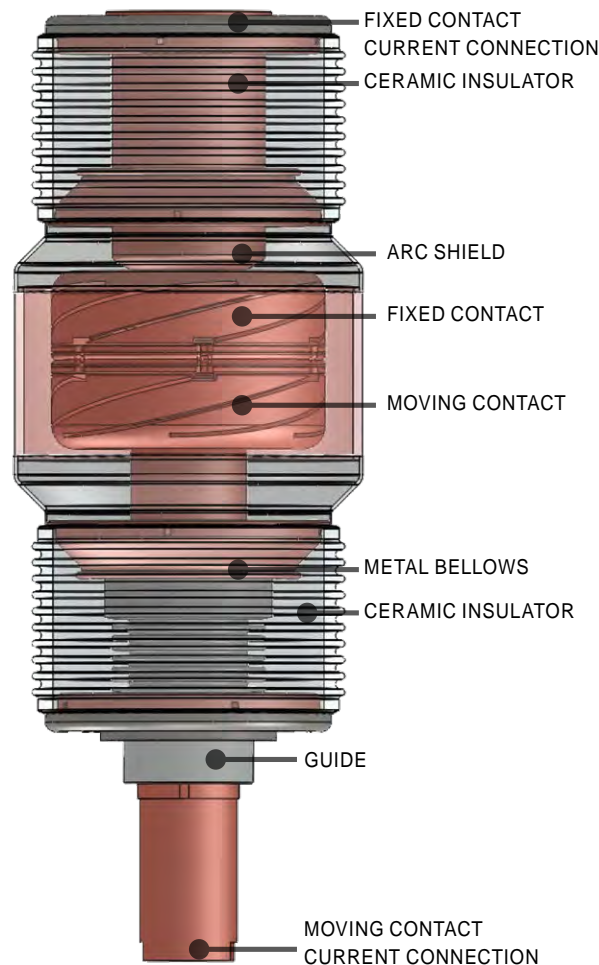

DRAWING 5

Customers should develop their own switchgear testing plan and data collection methodology prior to receiving switchgear and placing it in service. Baseline micro-ohm readings should be obtained by well-trained technicians using calibrated, certified utility grade test equipment only. A micro-ohm test set rated at least a 100 amp continuous with filtered output current should be used. Micro-ohm readings for the breaker's vacuum interrupters (VI) should be taken by making a good solid connection of the test set leads across the vacuum interrupter (VI) directly. Do not include any bolted joints, run back copper or finger clusters so that the baseline micro-ohm readings for the new vacuum interrupters are reflectively accurate. Additional micro-ohm baseline readings should be taken at the far end of the runbacks and on a piece of copper identical in size and geometry to the stationary primary disconnect bottle's conductor that is firmly inserted into the finger cluster. This will provide Users with baseline end-to-end micro-ohm readings across the breaker's entire power pole assemblies.

Regular testing by Users over the life of the breaker should include the retesting and comparison of these values.

Interrupter micro-ohm readings in and of themselves are not a preferred indicator of interrupter health.

Additionally; end to end readings are important to verify the quality of bolted connections, clamp connections, braid assemblies, finger cluster spring pressure and breaker mechanism / push rod closing pressure.

Should any of the following conditions develop;

- VI does not hi-pot properly per ANSI in-service standards for switchgear of that voltage class.
- The breaker's # of operations vs. interruption current is higher than depicted at the indicative point on the VI's Life Expectancy Curve.
- The VI contact erosion indicator is no longer visible (verify it was not un-view-ably rotated during initial assembly).
- The micro-ohm readings have increased by more than 100% of the initial readings. Push-rod spring pressure must be validated to achieve proper micro-ohm readings.
- The VI lower stem (moving terminal) temperature under full load (or less) current exceeds 105 degree C.

Send the breaker back to the manufacturer for servicing and parts replacing.

VACUUM INTERRUPTER / OPERATOR

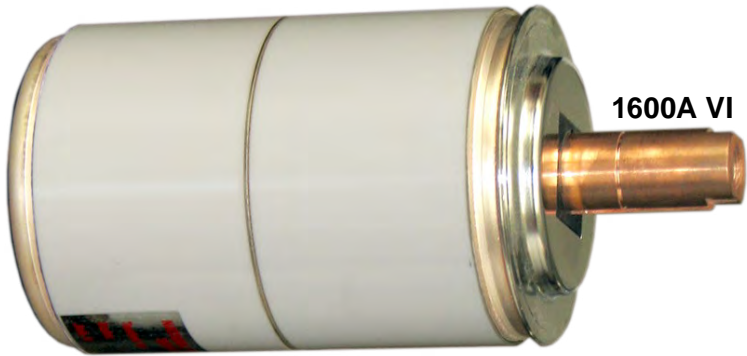

1600A VI

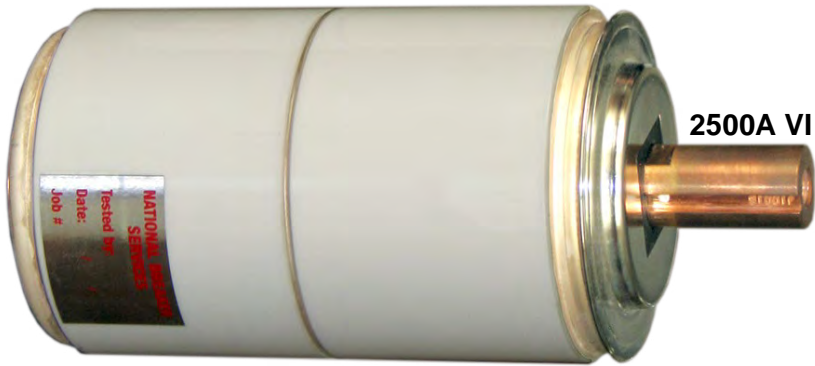

2500A VI



4000A VI



5000A VI

TABLE: 3

Vacuum Interrupter - Type: C14 - TECHNICAL DATA			
Rated Voltage	15 kV (60Hz)	Short-time (1min) power -frequency withstand voltage	38 kV
Rated current	1600 / 2000 A	Lighting impulse withstand voltage (peak)	95 kV
Rated frequency	50/60 Hz	Circuit resistance at rated contact force	≤10μΩ
Rated short circuit breaking current	31.5 kA rms	Mechanical life	20,000 operations
Operations of short-circuit breaking current interruption	100 operations	Contact erosion permission length	3 mm
Rated short-circuit making currentt	81.9 kA	Shelf life	20 years
Rated peak withstand current	81.9 kA	Weight/mass of moving parts	6.85 kg
Rated short-time withstand current (3s)	31.5 kA	Rated operating sequence	Open-0.3s-CO-180s-CO
Max. DC-component	36 %	Out of simultaneity of contact closing and opening	≤1 ms
Rated contact stroke	9 ± 1 mm	Max. overtravel	≤2 mm

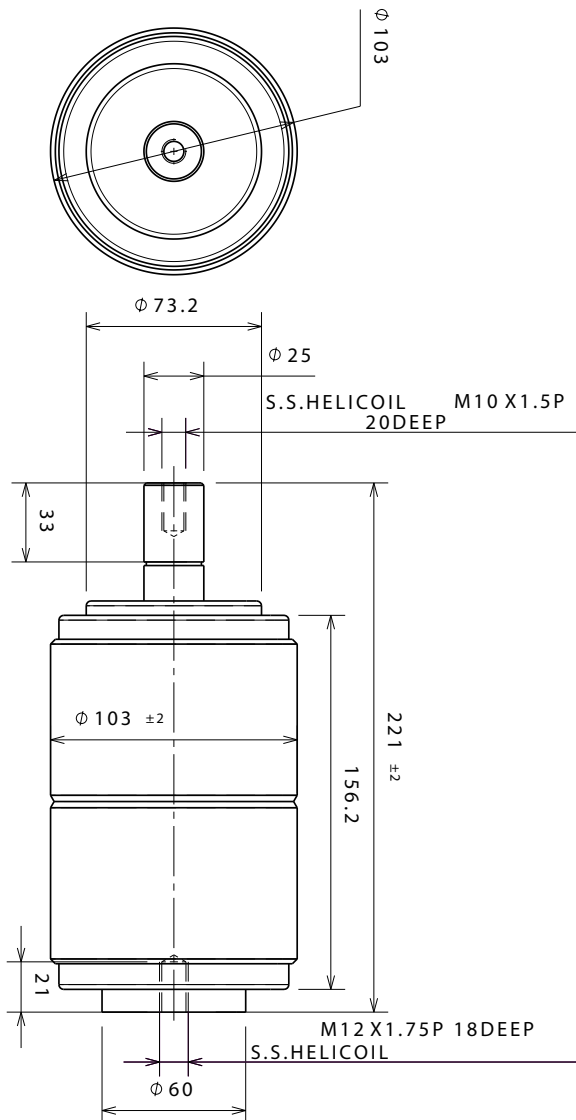

C14

TABLE: 4

Vacuum Interrupter - Type: B32 - TECHNICAL DATA			
Rated Voltage	15 kV (60Hz)	Short-time (1min) power -frequency withstand voltage	38 kV
Rated current	2000 / 2500 A	Lighting impulse withstand voltage (peak)	110 kV
Rated frequency	50/60 Hz	Circuit resistance at rated contact force	≤10μΩ
Rated short circuit breaking current	40 kA rms	Mechanical life	20,000 operations
Operations of short-circuit breaking current interruption	100 operations	Contact erosion permission length	3 mm
Rated short-circuit making currentt	104 kA	Shelf life	20 years
Rated peak withstand current	104 kA	Weight/mass of moving parts	6.85 kg
Rated short-time withstand current (3s)	40 kA	Rated operating sequence	Open-0.3s-CO-180s-CO
Max. DC-component	40 %	Out of simultaneity of contact closing and opening	≤1 ms
Rated contact stroke	9 ± 1 mm	Max. overtravel	≤2 mm

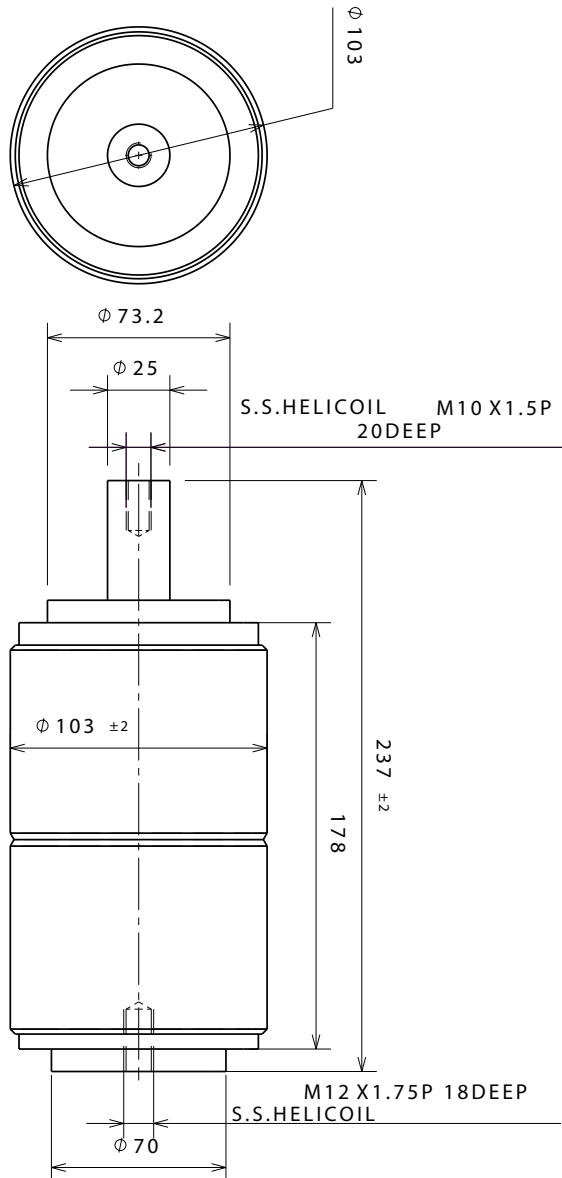

B32

Vacuum Interrupters Life Expectation Curve - ANSI C 37.09 breakers

The life expectancy of vacuum interrupters is a function of the number of interruptions and magnitude of current interrupted.

FIGURE: 8

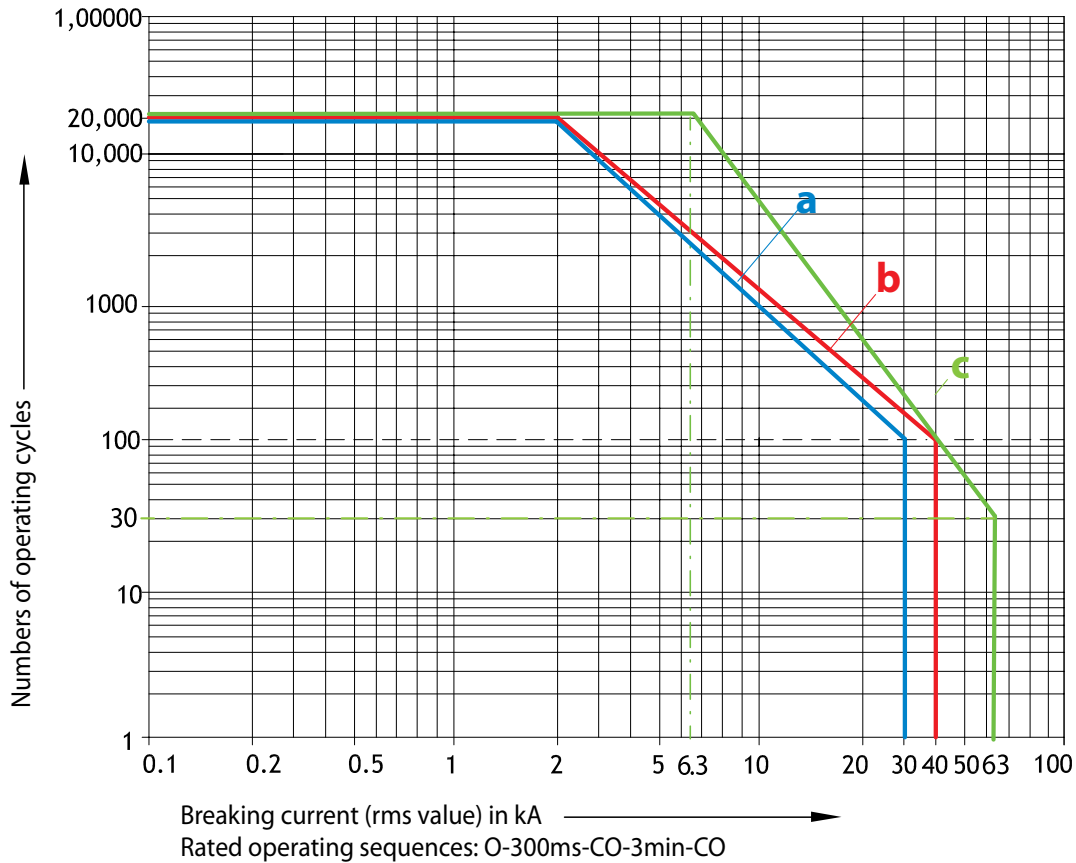

Electrical data

- a** Rated voltage : 15kV
Rated short-circuit breaking current:31.5kA
Rated normal current :1200A
- b** Rated voltage : 15kV
Rated short-circuit breaking current:40.0kA
Rated normal current :2000A
- c** Rated voltage :15kV
Rated short-circuit breaking current:63.0kA
Rated normal current :4000A

Breakers must have vacuum interrupter assemblies replaced when they achieve maximum-life curve limits, when erosion dot is no longer visible or if micro-ohm readings are greater than 100% above specified nominal.

Vacuum Interrupters Life Expectation Curve - ANSI C 37.013 breakers

The life expectancy of vacuum interrupters is a function of the number of interruptions and magnitude of current interrupted.

FIGURE: 9

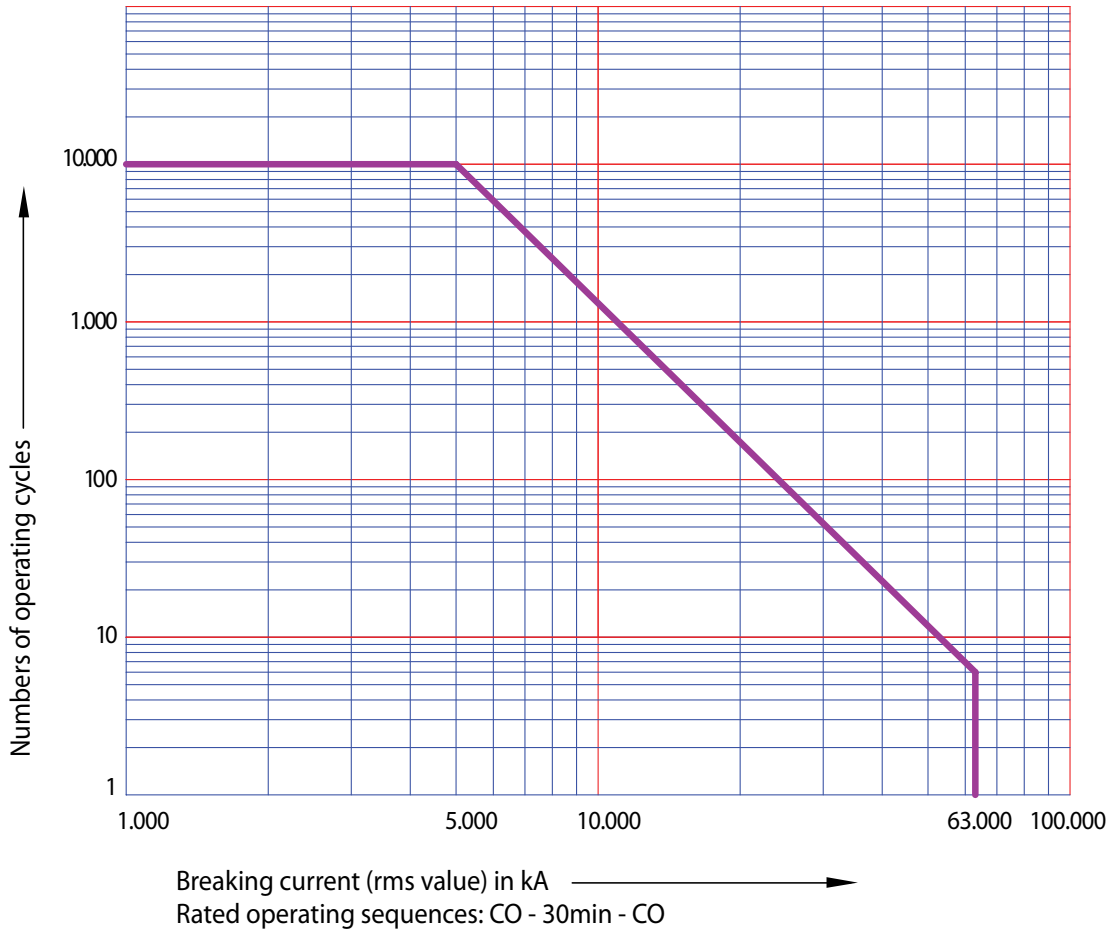

Rated voltage: 15kV
 Rated short-circuit breaking current: 63.0kA
 Rated normal current: 5000A

Breakers must have vacuum interrupter assemblies replaced when they achieve maximum-life curve limits, when erosion dot is no longer visible or if micro-ohm readings are greater than 100% above specified nominal.

TABLE: 7

Vacuum Interrupter - 38 kV / 3000 A - 44 kA - TECHNICAL DATA - NBS - CGD - 2297G2			
Rated Voltage	38 kV	Short-time (1 min) power frequency withstand voltage	80 kV RMS
Rated current	3000A	Lighting impulse withstand voltage	200 kV
Rated frequency	60 Hz	Circuit resistance at rated contact force	≤16μΩ
Rated short circuit breaking current	44 kA rms	Mechanical life	10,000 operations
Allowable contact erosion	3 mm	# of short-circuit breaking interruptions	20 operations
Rated short-circuit making currentt	115 kA	Rated contact stroke	22 ± 2 mm
Rated peak withstand current	115 kA	Out of simultaneity of contact closing and opening	≤2 ms
Rated short-time withstand current (3s)	44 kA	Max. overtravel	≤3 mm
Max. DC-component	40%	Shelf life	20 years

Model # NBS - CGD - 2297-G2

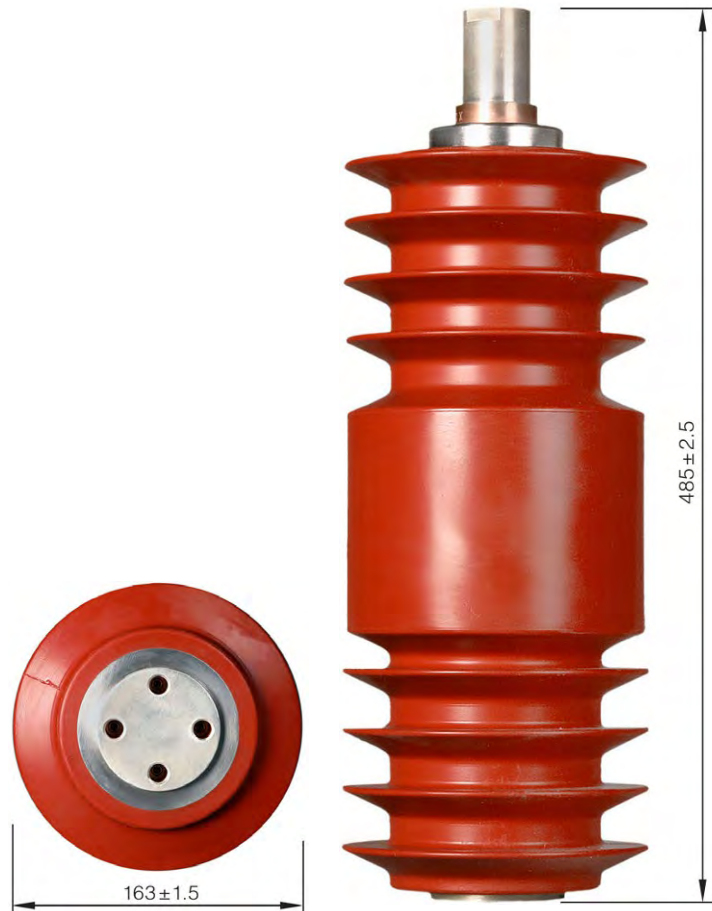
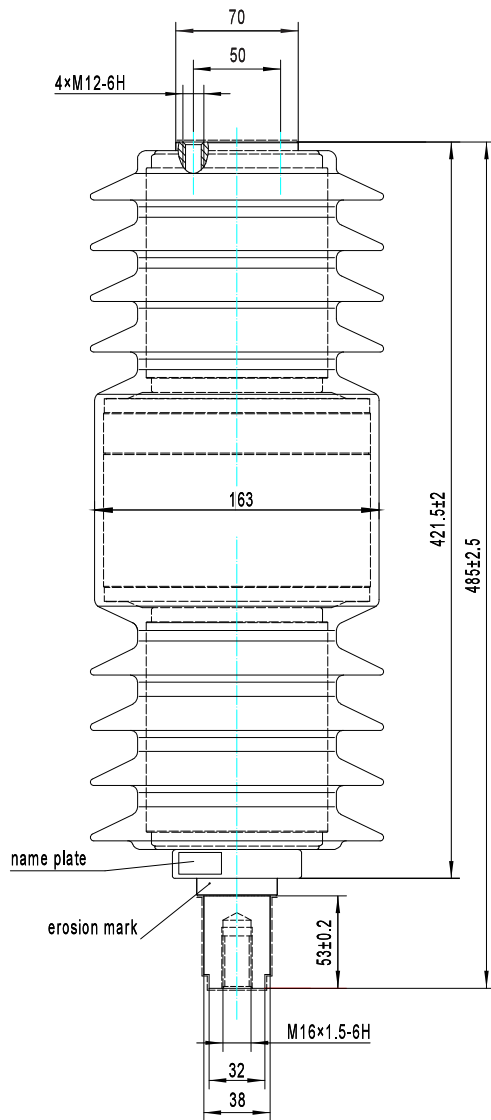

Rated operating sequence; Open-0.3s-CO-180s-CO

General Construction concept of Citadel vacuum breaker elements

Vacuum circuit breakers consist of a source of mechanical power that in turn operates on an interrupting medium in this case a vacuum interrupter.

Based on construction needs of the switchgear breaker elements can be fixed mounted or draw-out type.

The Citadel operator mechanism is an energy-storing spring type system with most of the controls and actuating devices located within the operator mechanism's enclosure (housing).

Narrow element Citadels (24 inch switchgear type), have primary power pole assemblies that are fixed to the rear of the operating mechanism housing by a custom three sided molding assembly that surrounds the vacuum interrupter.

The entire molding is designed to solidly bolt to the rear of the mechanism enclosure. The molded assembly also provides bolting capabilities to allow primary conductor attachments (runbacks) to the vacuum interrupter's upper and lower points of connection. These runback bus bars are either hole punched at their far ends for bolted connections or have movable connectors (which go by more familiar names of "finger clusters" or "movable primary disconnects") attached to their far ends for use in conjunction with its associated draw-out switchgear.

In the case of higher amperage or higher interrupting (36 inch switchgear type) Citadel elements (3,000 to 5,000 amps; 50kA and 63kA) the pole supports are custom designed stand-off insulators bolted to metallic heat sink castings. The upper or lower heat sink castings are each designed to "capture" either their associated vacuum interrupter's stationary or moving contact assembly side.

See: "Bolt Size and Torque Values" Chart for more detailed hardware and connection information (pages 107 to 113)

Inter-Phase barriers (as applicable);

Panels of GPO-3 (red) glass-polyester insulating material are located around the circuit breaker's main primary pole assemblies to provide suitable electrical insulation between the vacuum interrupters and ground plane locations in the cubicle.

Primary connections (refer to images in page 39)

Item #2 in Figures 12 and 13 illustrates provisions to make up the primary power connections of a draw-out Citadel. These movable connectors go by more familiar names such as "finger clusters", "movable primary disconnects", "movable primary stabs". Each circuit breaker has three upper (one per phase) and three lower (one per phase) primary disconnect points, providing detachable connections to the main current carrying bus bars in the switchgear. For fixed mounted circuit breakers, bus bar conductors (or landing pads) are provided to bolt directly to bus bar.



FIGURE: 10

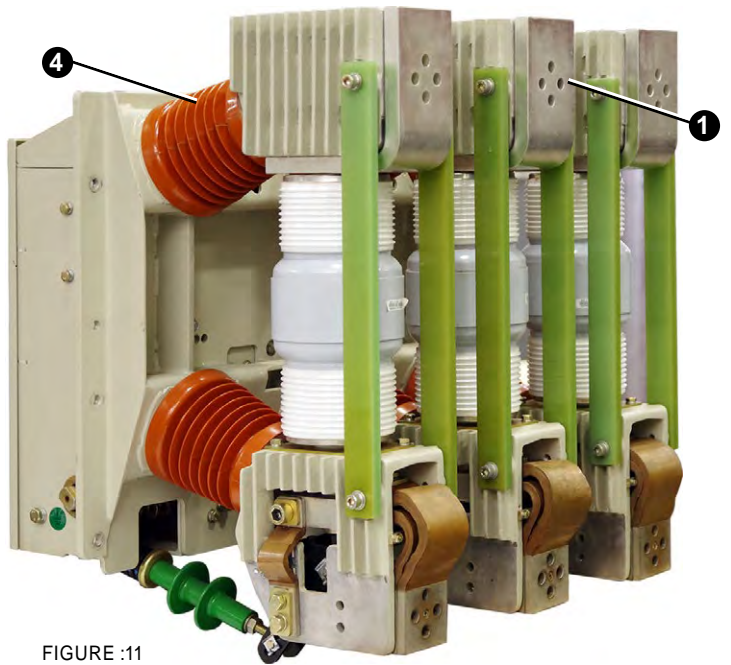

FIGURE :11

1. Bolted Landing Pads For Busbar Connectors
2. Finger Cluster Primary Connectors
3. Interphase Barriers
4. Pole support stand off insulator

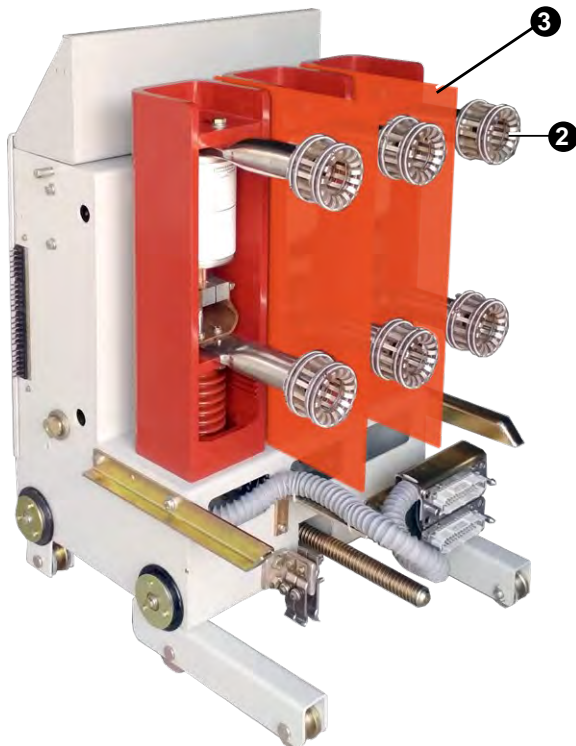

FIGURE: 12

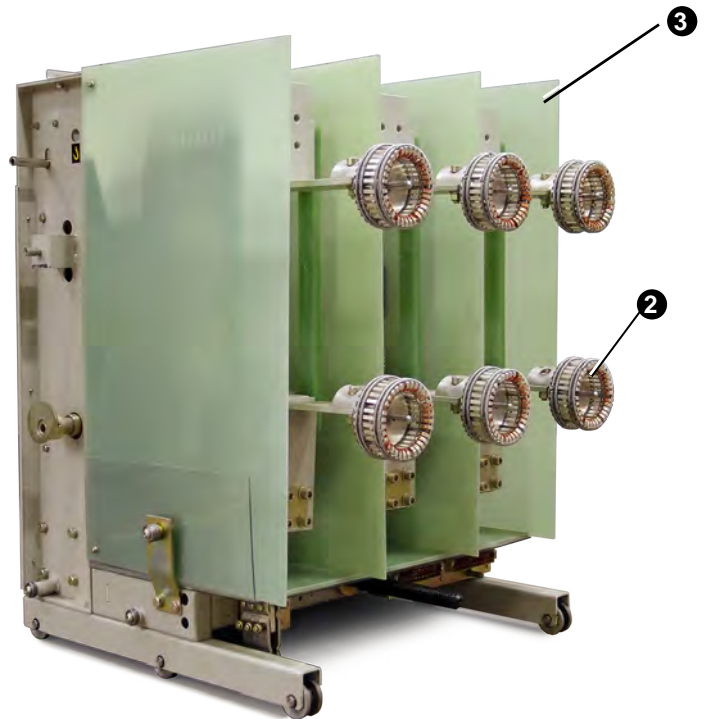

FIGURE :13

CITADEL CONTROLS

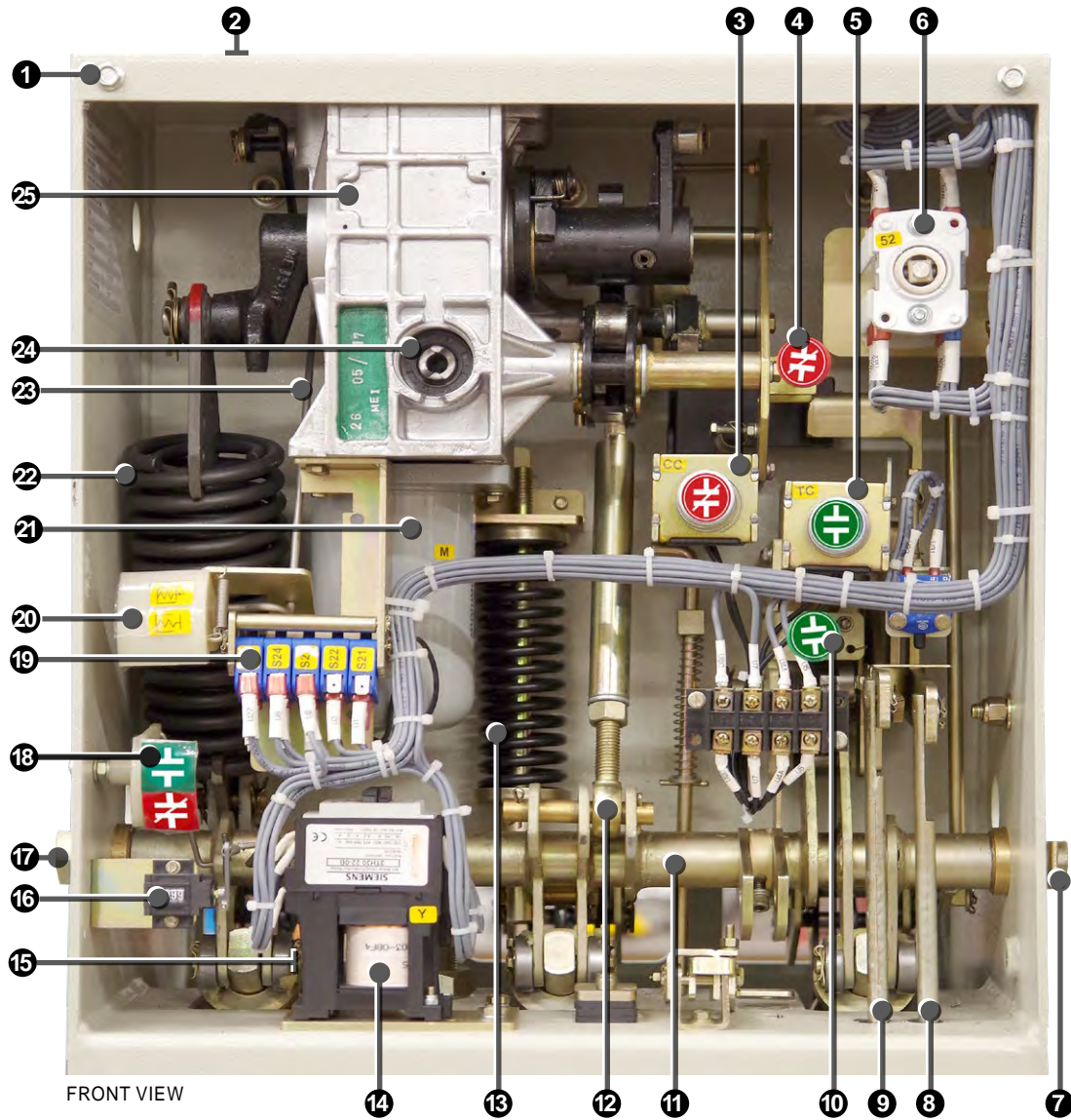

FIGURE: 14

1	Housing Enclosure	14	Anti-Pumping Relay (X-Y)
2	Terminal Block(s) (fixed Element Only)	15	Shock Absorber (Behind item 14)
3	Closing Solenoid	16	Operations Counter
4	Manual Closing Button	17	LH MASTA
5	Open Solenoid	18	Open/Close Indicator
6	Auxiliary Switch	19	Limit Switches 1, 2, 3, 4, 7
7	RH MASTA	20	Spring Charged Indicator
8	Trip Linkage Takeoff	21	Charging Motor
9	Close Linkage Takeoff	22	Closing Spring
10	Manual Open Button	23	Microswitch Linkage Rod
11	Breaker Main Armature Shaft	24	Manual Charging Gear Port
12	Main Drive Rod	25	Gearbox Mechanism
13	Opening Spring		

Stored-energy operating mechanism;

The stored-energy operating mechanism of the circuit breaker is a balanced system of springs, solenoid coils and mechanical devices designed to provide a number of specific and critical functions.

The energy necessary to close and open the contacts of the vacuum interrupters is stored in a powerful Closing spring and somewhat smaller Opening springs.

Under normal operation, each time the Closing spring discharges its energy, the breaker mechanism’s charging motor will automatically recharge the Closing spring. There are also provisions for manual charging of the closing spring for emergency conditions where control power is lost or during manual charging for testing and maintenance purposes.

“Trip-free” is a function specified in ANSI/IEEE C37.04-1999, clause 6.9 which states that the tripping function prevail over the closing function. See ANSI/IEEE C37.04-1999 for full details or consult the factory.

The Citadel vacuum breaker element consists of three phases (AKA poles), each with its own vacuum interrupter, which is rigidly supported by a primary mounting assembly. These three “pole assemblies” are bolted to a common operating mechanism housing. (Figure 15).

1	Closing Spring
2	Opening Spring
3	Main Armature Shaft
4	Main Drive rod
5	Main Shaft Linkage to Push Rods

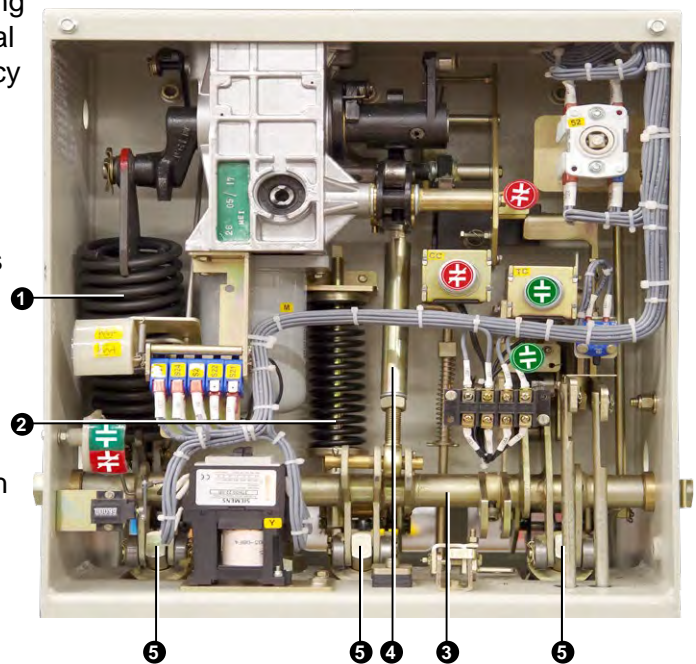

FIGURE 15

Operating mechanism

The operating mechanism is comprised of the mechanical and electrical components required to:

1. Charge the closing spring to be able close the circuit breaker and simultaneously store energy in the opening spring and contact pressure springs.
2. A latching and triggering mechanisms to release closing and opening spring’s actions.
3. Means of transmitting the forces and motions to each set of vacuum interrupters within the pole assemblies.
4. Operate all functions automatically by way of an electrical charging motor, a close and open coil, cutout switches, anti-pump relay, and an auxiliary switch.
5. Provide indication of the circuit breaker status (OPEN/CLOSED), spring condition (CHARGED/DISCHARGED) and an operations counter.

Secondary Wiring

Control power and control signals (both input and output) are engaged / dis-engaged to the Draw-out Citadel element via a multi-point moving secondary contact assembly. (figure 16)

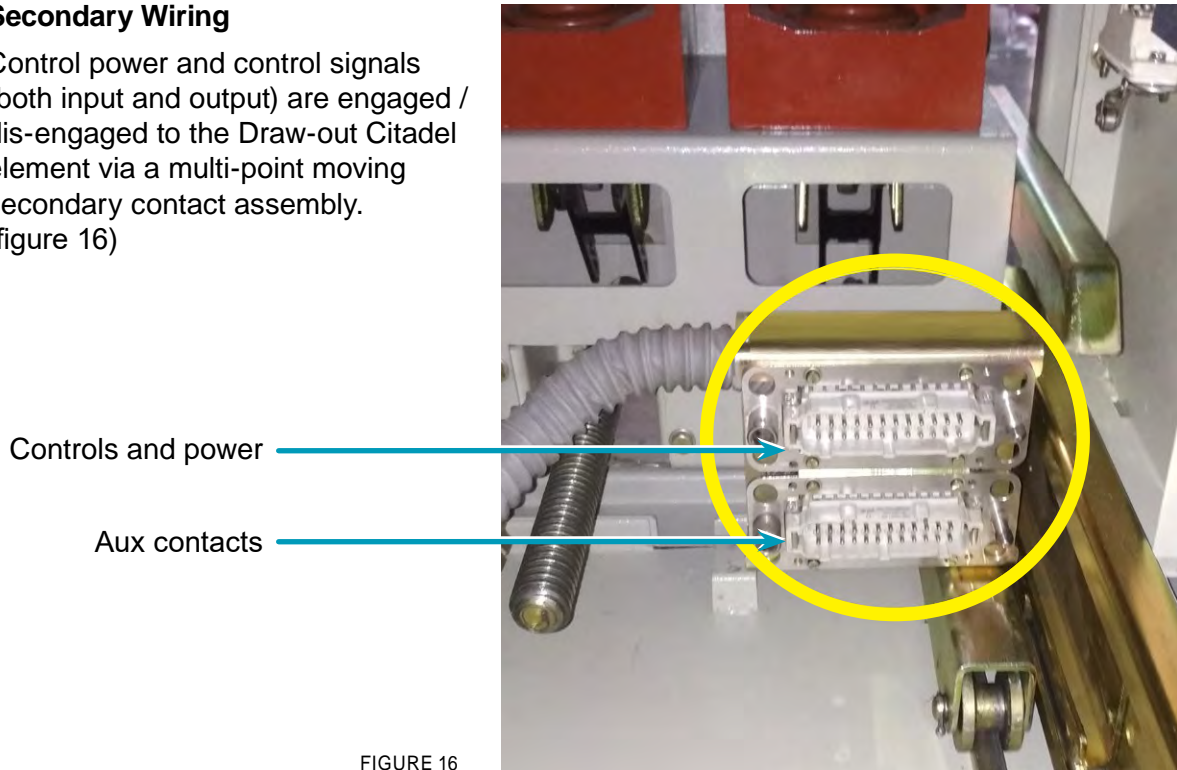

FIGURE 16



FIGURE 17

For fixed mounted Citadel elements – all the control wiring points are conveniently brought to a multipoint terminal block mounted on the top of the breaker mechanisms enclosure for ease of customer connections and interfacing with external circuits.

Motor-operating mechanism

(refer to Figure 18)

The spring-charging motor is bolted to the bottom of the charging mechanism’s high-torque anti-slip gear box. This combination sub-assembly is installed in the upper left quadrant of the operator mechanism’s housing. Neither the charging mechanism or the motor require any maintenance, beyond noted external lubrication points (see recommended **maintnance lubrication pages**).

As soon as the closing spring performs its function and discharges – the charging motor is energized and called on to operate via mechanism operated micro switches.

The Citadel breaker then recharges the closing spring after a closing operation.

TABLE 8

ANSI/IEEE C37.06 control voltages				Charging time Seconds
Nominal	Ohm's at 20°	Spring charging motor (A)		
		Run (Average) ¹	Inrush (Peak)	
24 Vdc	3.7	16.0	45.0	10
48 Vdc	4.8	8.0	24.0	10
125 Vdc	6.7	4.0	16.0	10
250 Vdc	10.2	2.0	8.0	9
120 Vac	6.7	4.5	18.0	9
220 Vac	10.2	2.5	10.0	9

Footnote: (1) Current at nominal voltage

FIGURE 18



CAUTION



Motors inherently have little ability to withstand elevated voltages. When performing ANY type of elevated voltage - Insulation Resistance (IR) testing (AKA - Meggering, hi-poting etc..) of Citadel breaker secondary circuitry – ALWAYS disconnect the motor’s circuit leads to insure no elevated voltages appear on the motor’s terminals. **It is the sole responsibility of the testing and maintaining person(s) to properly reconnect motor leads before breakers are placed back into service.**

CAUTION



Never test motor insulation with applied voltages above 700V

TABLE 9

Spring charging time			≤ 12 s
Opening time from energization of trip coil at rated control voltage to contact parting (last pole), not including arcing time	5-cycle interrupting time (83 ms)	Up to 15.5 kV	≤ 66 ms
	3-cycle interrupting time (50 ms)	Up to 15.5 kV	≤ 38 ms
Close time from energizing close coil at rated control voltage to contact touch (last pole)		Up to 15.5 kV	≤ 56 ms

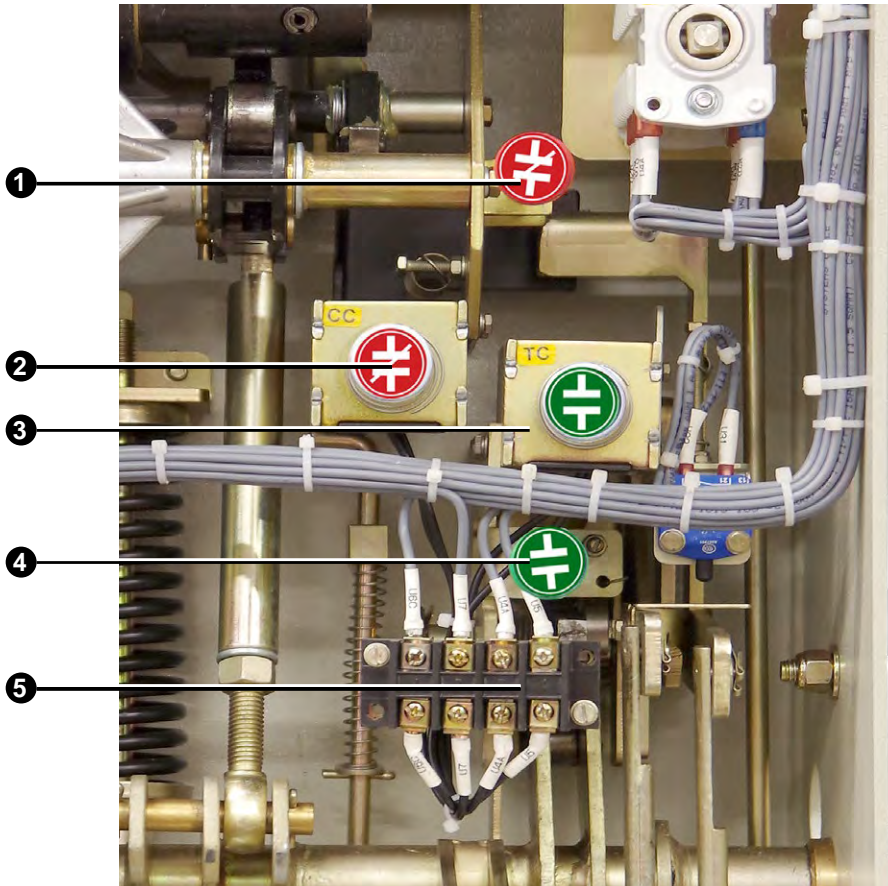

1	Manual Close Button
2	Close coil
3	Trip coil
4	Manual Open Button
5	Operating Coil Terminal Block

FIGURE19

Close coil (52CC)

The close coil is a standard component of the Citadel circuit breaker used to close the circuit breaker electrically by unlatching the closing spring and releasing its stored energy.

Close Coils are available for AC or DC control voltages as prescribed in the ordering information sheets. Generally available close coil control voltages are 48, 125 & 250 VDC and 120 & 230 VAC.

AC control voltages will employ a rectifier in the circuitry prior to connection to the close coil. The close signal is a momentary electrical pulse that is sent to the close coil and then removed by electrical auxiliary contacts within the Citadel breaker mechanism.

Trip coil (52T)

The trip coil is a standard component of the Citadel circuit breaker used to open the circuit breaker electrically by means of a direct action solenoid armature unlatching and releasing the stored energy of the opening spring.

Trip Coils are available for DC voltages as prescribed in the ordering information sheets. Generally available trip coil control voltages are 48, 125 & 250 VDC.

Close and trip coils are hard wired to a terminal block to ensure a most rugged connection.

Close and trip coils are the same coil when voltages in the breaker are the same.

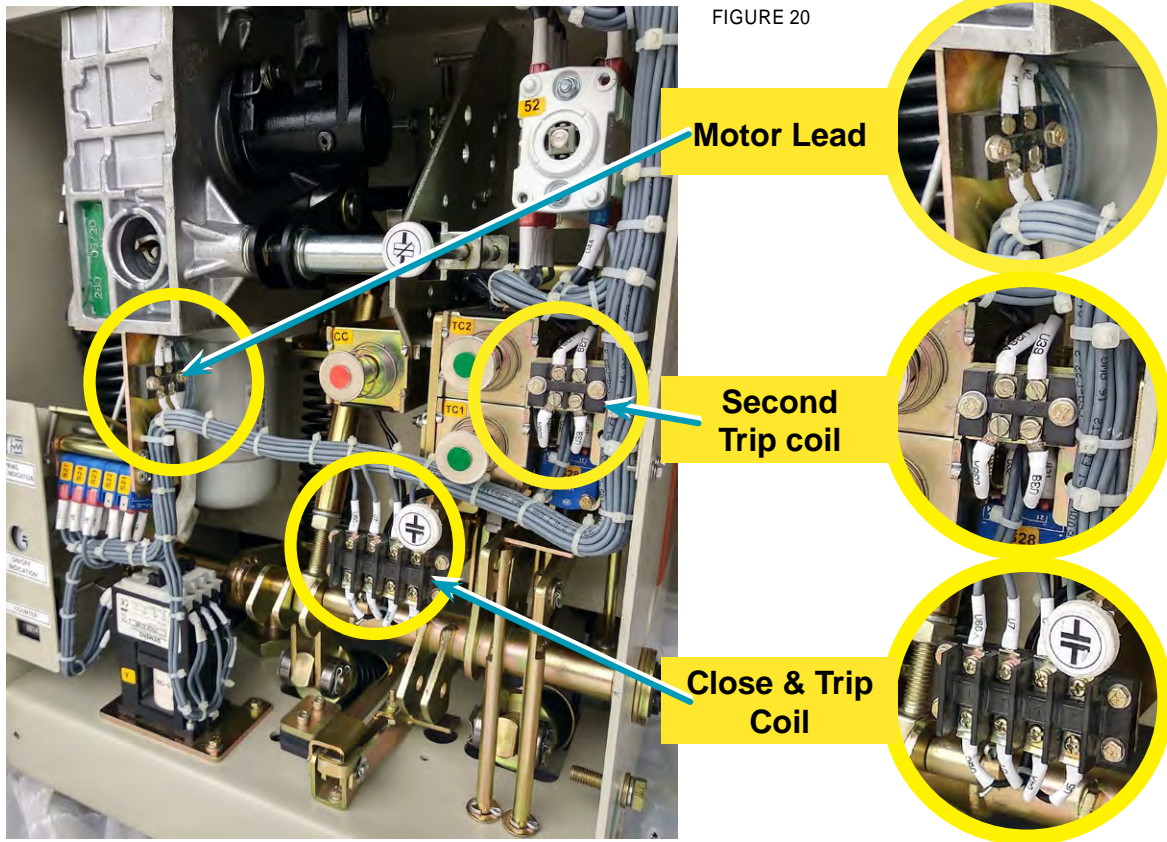

FIGURE 20

TABLE 10

ANSI/IEEE C37.06 control voltages		Close coil	Trip coil	Coil resistance in ohm's	
Nominal	Range ⁵		A ¹		A ¹
	Close	Trip			
24 Vdc	19-28	14-28	Consult Factory		2.5
48 Vdc	36-56	28-56	6.5	11.0 / 20.0 ³	8.0
125 Vdc	⁶ 90-140	70-140	2.1	3.2 / 6.0 ³	43.0
250 Vdc	180-280	140-280	1.2	1.9 / 3.5 ³	158.0
120 Vac	104-127	--- ⁴	2.4	--- ^{2,4}	43.0
240 Vac	208-254	--- ⁴	1.3	--- ^{2,4}	158.0

Footnotes:

- (1) Current at nominal voltage
- (2) Capacitor trip
- (3) Value preceding slash (/) is the current for the standard trip coil with standard rating interrupting time. Value following (/) is current for optional trip coil with three-cycle interrupting time.
- (4) ---- means this selection is not available at this voltage.
- (5) ---- consult factory for special extended ranges.
- (6) 90V is standard for The Citadel

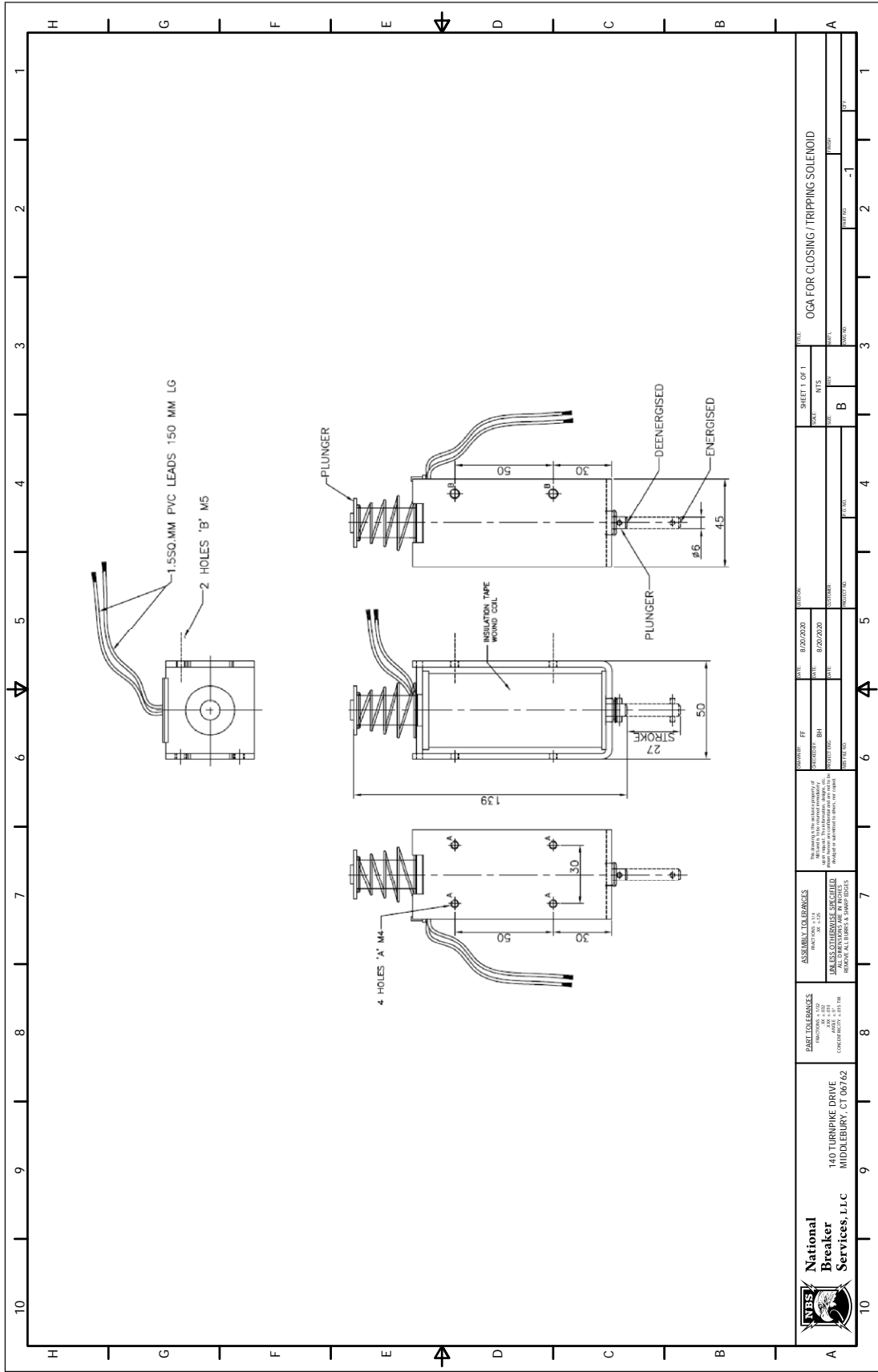

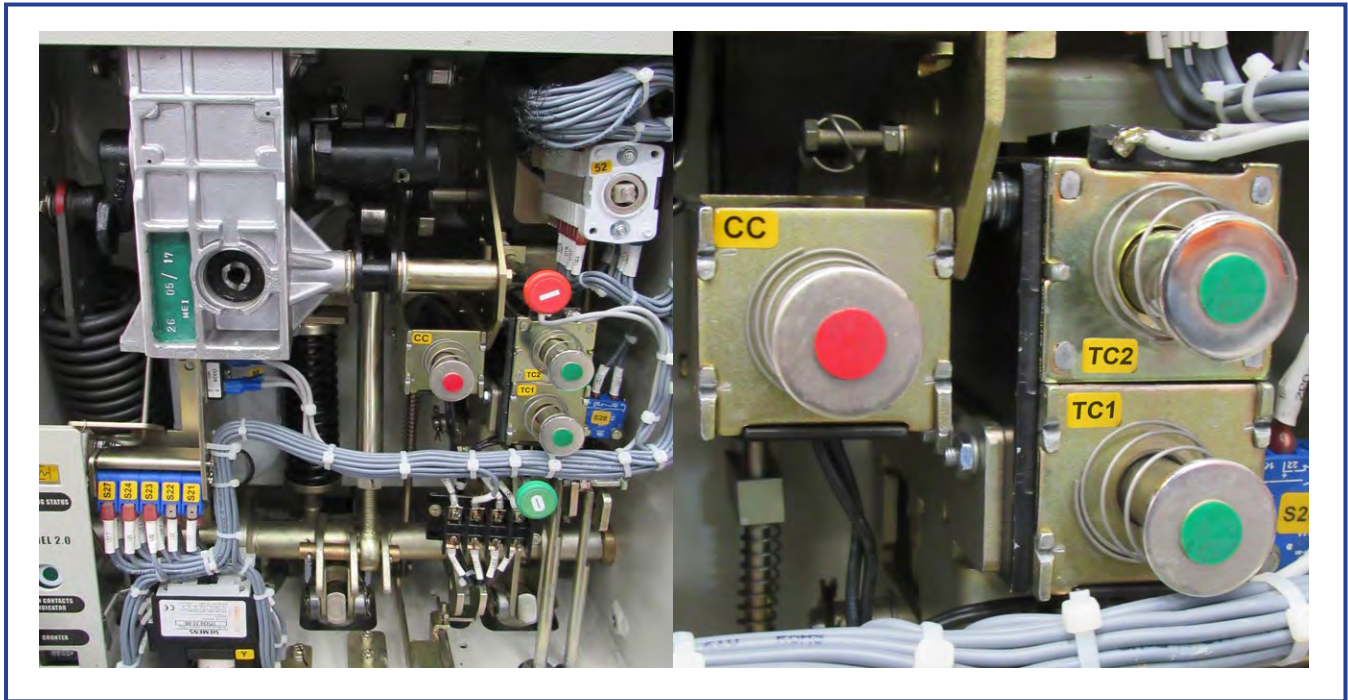

FIGURE 21

Dual Trip coils

The Trip coils electrically open the circuit breaker from a signal provided by protective relays or other control devices.

When more than one trip coil is desired a second trip coil can be provided and is generally connected to a separate control power source than the main trip coil.

Capacitor trip device (optional)

Capacitor trip devices can be thought of as short term batteries providing an adequate electrical energy storage to ensure circuit breaker tripping if control power is lost.

The capacitor trip devices are installed in the drawout circuit breaker switchgear enclosure. These devices provide an independent control power tripping source for installations lacking station batteries.

The capacitor trip takes available 120 or 240 Vac to charge a large capacitor.

The capacitor trip device will provide short-term tripping energy for circuit breaker.

The Citadel incorporates a number of micro-switches within its control circuitry. Customers should familiarize themselves with the Citadel's control schematic for their specific breakers' to understand the function of each of the micro switches. If breaker controls are working properly and no concerns exist regarding the micro-switches / no maintenance need be considered. If breaker control concerns exist, micro-switch inspection can be considered as per the following page;

Micro-Switches associated with closing spring:

FIGURE 22



Gang operated. S21-S22-S23-S24-S27
 These switches are operated by a rod connected to the closing spring's crank arm off the main differential gearbox assembly.

FIGURE 23

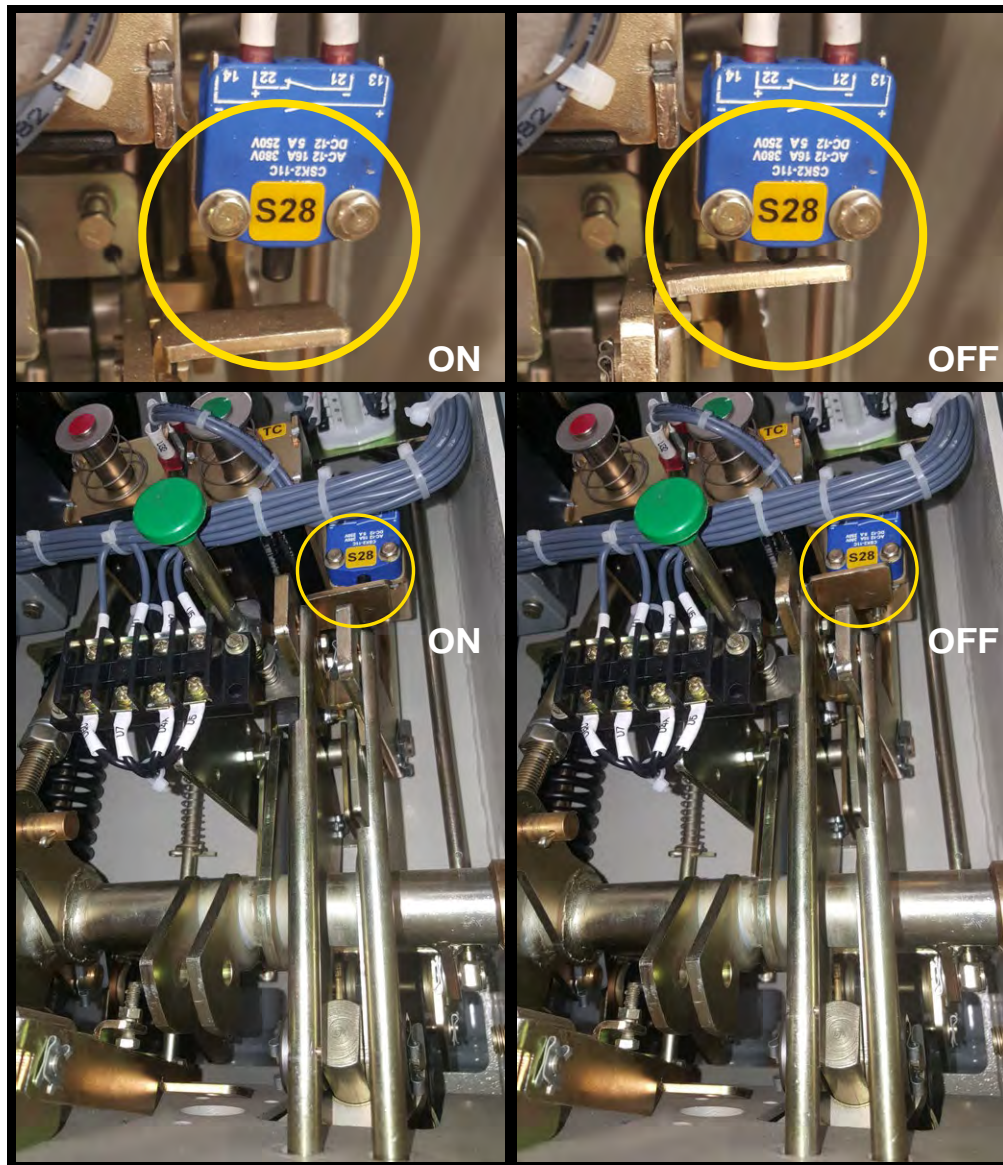

Micro-switch S28 - cuts motor circuit during racking procedure.

If Citadel breaker control component concerns exist;

Micro-Switch Checks should include:

- No breakage or excessive wear of the plastic housing.
- Proper alignment of the switch plunger.
- Proper throw of the device pushing & releasing the plunger.
- Electrical integrity of the wiring connections to the micro-switch.
- Integrity of the switches operation by using an ohmmeter across switch output terminals with at least one of the leads removed.

Push plunger & insure switch opens and closes properly with virtually no electrical resistance in the closed position. Verify switch is changing contact state correctly as per the movement of its driving actuator pin.

Micro switches # 29 & 30 are activated by the “Block the Close” mechanism. When the Citadel racking tool is inserted or the breaker is in between Disconnect and Connect positions – Block the Close mechanical interlocking will cut off the Close Coil #29 & Charging Motor #30

FIGURE 24

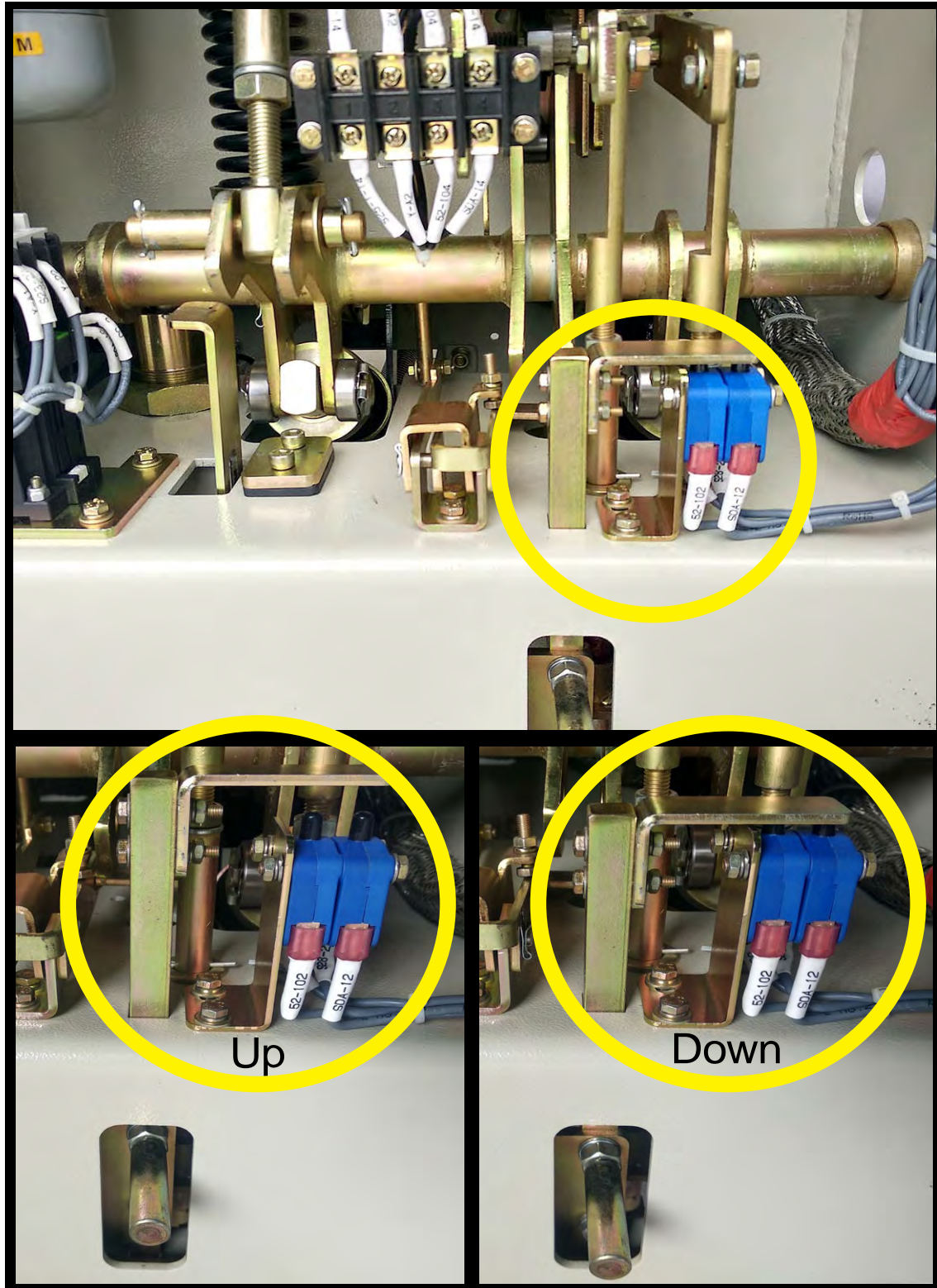

Auxiliary switch (52a/b)

The Citadel circuit breaker has a multi contact auxiliary switch within its mechanism (see figure 25). This switch provides numerous auxiliary contacts for internal circuit breaker control use during closing and opening. Spare contacts are standard and optionally available for Customer use as desired. The Auxiliary switch is driven by linkage that connects to and is moved by the Main Armature shaft.

The auxiliary switch contains both normally closed (“b” contacts) and normally open (“a” contacts). “a” contacts follow the main breaker’s primary contacts – i.e. when the circuit breaker is open, the “a” contacts are open and the “b” contacts are closed.

FIGURE 25



TABLE 11

Auxiliary Switch Parameters	
Product Name	Auxiliary Switch (10 NO +10NC)
Type	F10-20
Rated voltage	415 V
Power freq. withstand 1 min	2000 V
Breaking capacity	16 amps AC / 415V @ 0.7pf
DC Breaking capacity	2A @ 220V,
	4A @ 110V,
	10A @ 48V,
Electrical life	20,000 operations
Mechanical life	30,000 operations

TABLE 12 - INTERRUPTING CAPACITY AUXILIARY SWITCH CONTACTS

Type of circuit	Continuous current (A)	Control circuit voltage				
		120 Vac	240 Vac	48 Vdc	125 Vdc	250 Vdc
Non-inductive	16	10	5	10	9.6	4.8
Inductive	10	6	3	10	6	3

SWITCHGEAR CUBICLE & DRAW-OUT FEATURES

The following section will focus on the Citadel Features that work in harmony between the breaker cell

FIGURE 26



- List of features**
1. Breaker rack position indicator
 2. Cell door 3 point latch handle with hasp
 3. Breaker Open Close status indicator
 4. Closed door racking port with locking capability

FIGURE 27

- List of features**
5. Breaker rack position indicator actuator
 6. 3 point latch mechanism
 7. Breaker Open Close indicator actuator
 8. Rear of closed door racking port

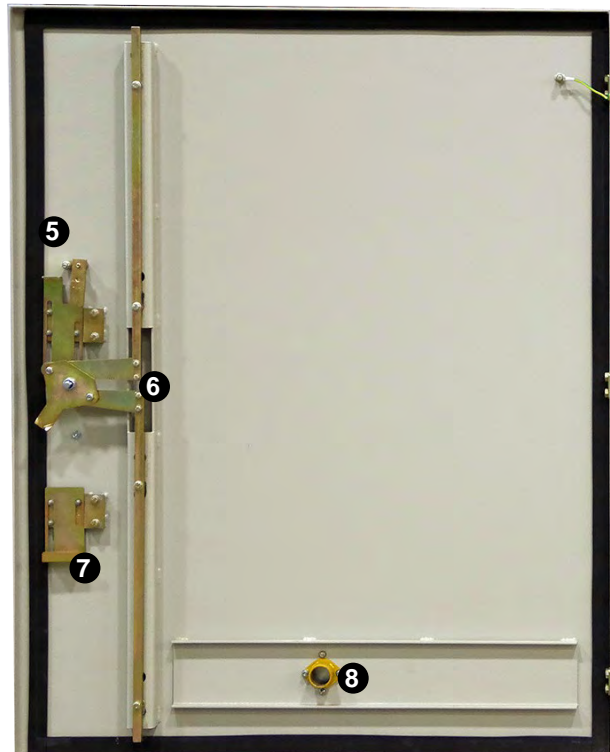

Heavy Duty Stainless Steel Hardware

Solid handle with large eye for padlocks and LOTO devices Heavy Duty Hinges for long life and smooth operation

FIGURE 28

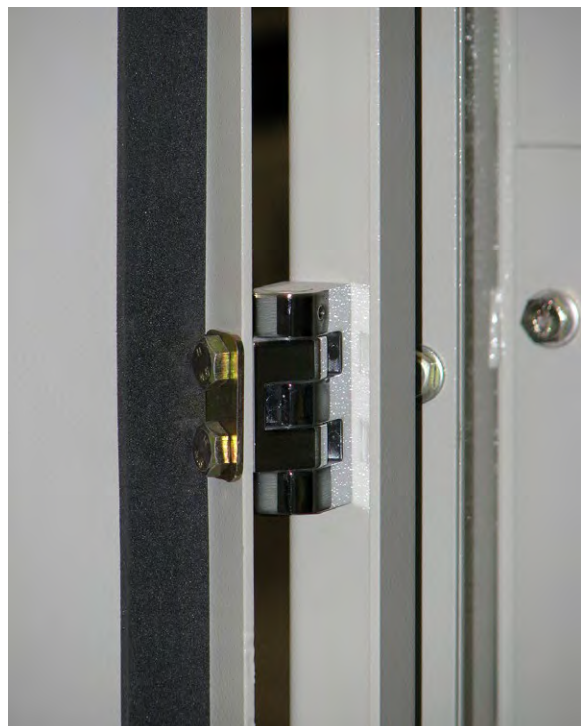

FIGURE 29



FIGURE 30

FIGURE 31



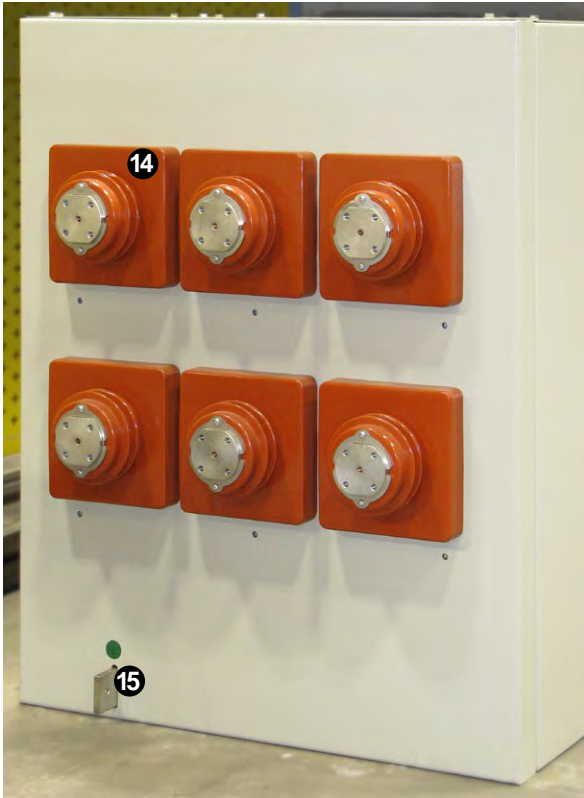

FIGURE 32

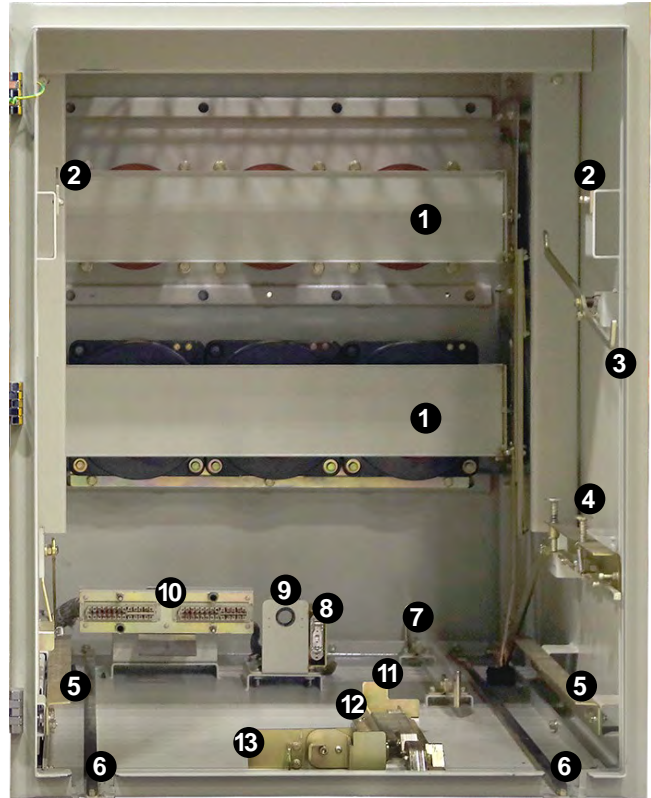

FIGURE 33

List of features

1. Primary shutter assembly
2. Disconnect position latch brackets
3. Rack position indicator arm
4. Breaker Open | Close position actuator assembly
5. Breaker hold down bracket
6. Racking rails
7. Ground Copper
8. TOC#2
9. Racking nut assembly
10. Stationary secondary assembly
11. Breaker Rating rejection bracket
12. Floor Close | Trip | Permissive lifter assembly
13. Breaker position locking bracket assembly
14. Rear of stationary primary disconnect
15. Rear of ground copper

FIGURE 34

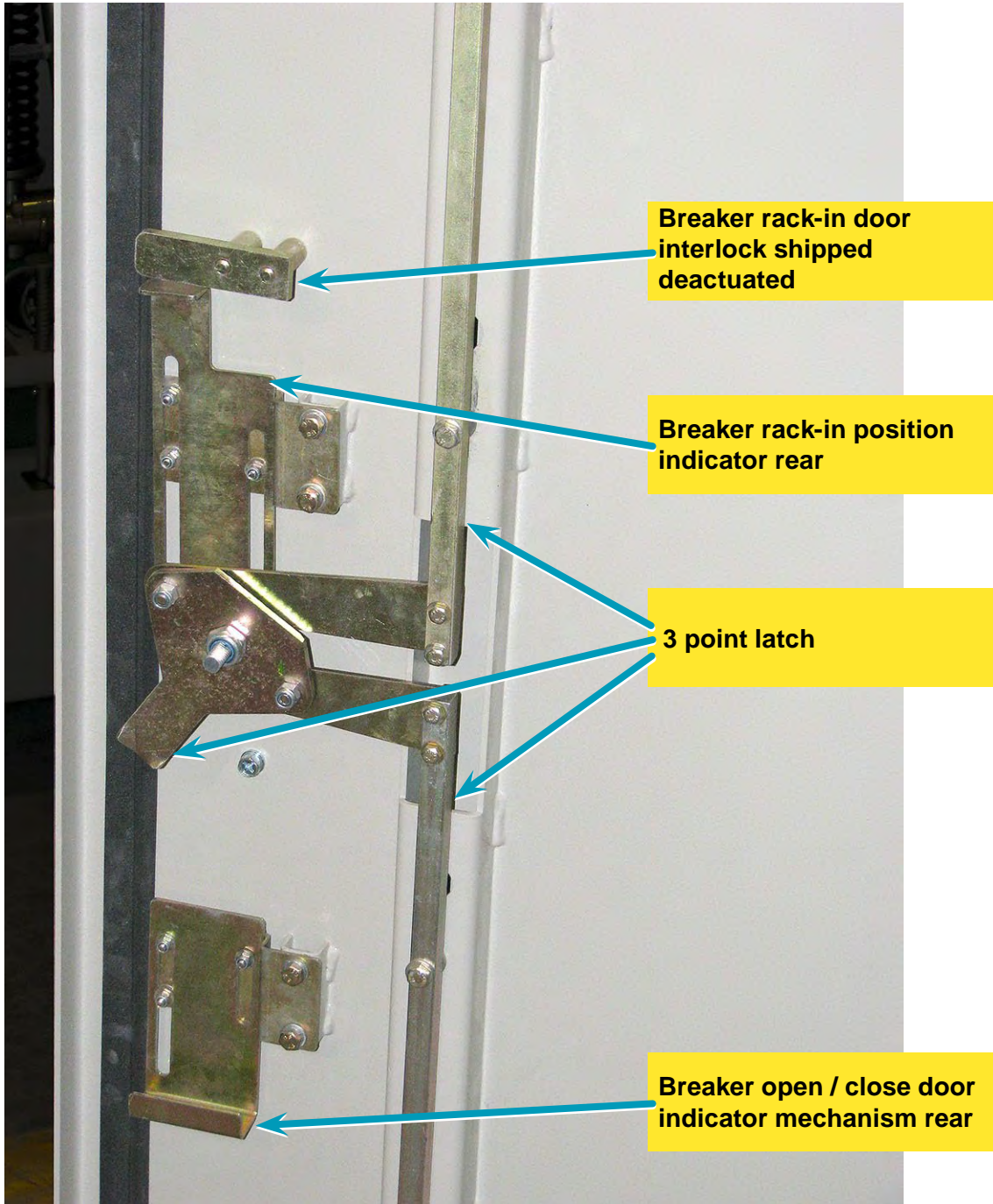



FIGURE 35A

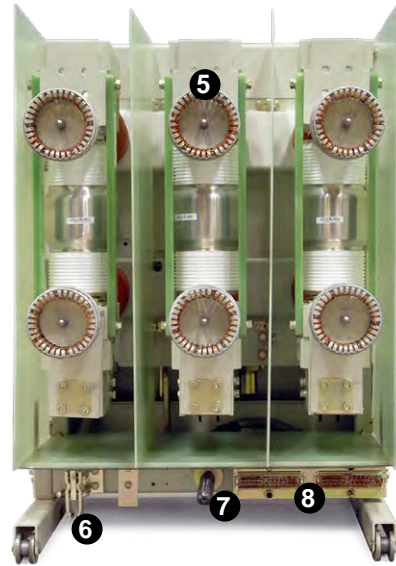

FIGURE 35B

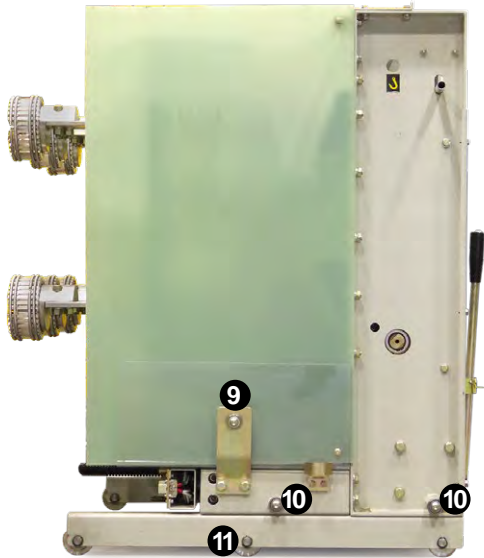

FIGURE 35C

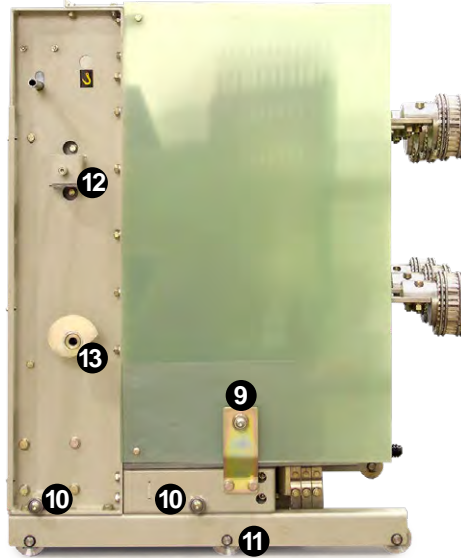

FIGURE 35D

List of features

- | | |
|---|--|
| <ol style="list-style-type: none"> 1. Ergonomic handle 2. Disconnect position latch 3. Moving secondary connection button 4. Manual charging port 5. Finger clusters 6. Ground shoe | <ol style="list-style-type: none"> 7. Racking screw 8. Movable secondary connector assembly 9. Shutter lifter rollers 10. Hold down pins 11. 6th wheel 12. Racking position rocker arm sliding pin 13. Breaker Open Close cam |
|---|--|

Breaker Racking Position Rocker Arm

As the Citadel breaker racks into the connect position - the front of the breaker racking position rocker arm seesaws upwards.

As it does - it moves the breaker position indicator actuator on the inside of the switchgear front door which move the semaphore indicator on the front of the switchgear door indicating the breakers positions (disconnect / connect).

Optionally - the dogleg in the racking arm can engage a latch on the inside of the front door to insure that no one can open the switchgear door if the breaker is racked into the connect position.

This feature comes disabled. It can be enabled by desirous customers.

NOTE; the switchgear door CANNOT be open unless breaker is tripped open and racked into the disconnect position through the closed switchgear door.

Any attempt to open the door with the breaker in any position OTHER than fully Dis-Connected, WILL damage parts if force is exerted.

This condition will NEVER be considered a warranty claim and WILL do material damage and possible personal injury if attempted.

FIGURE 36

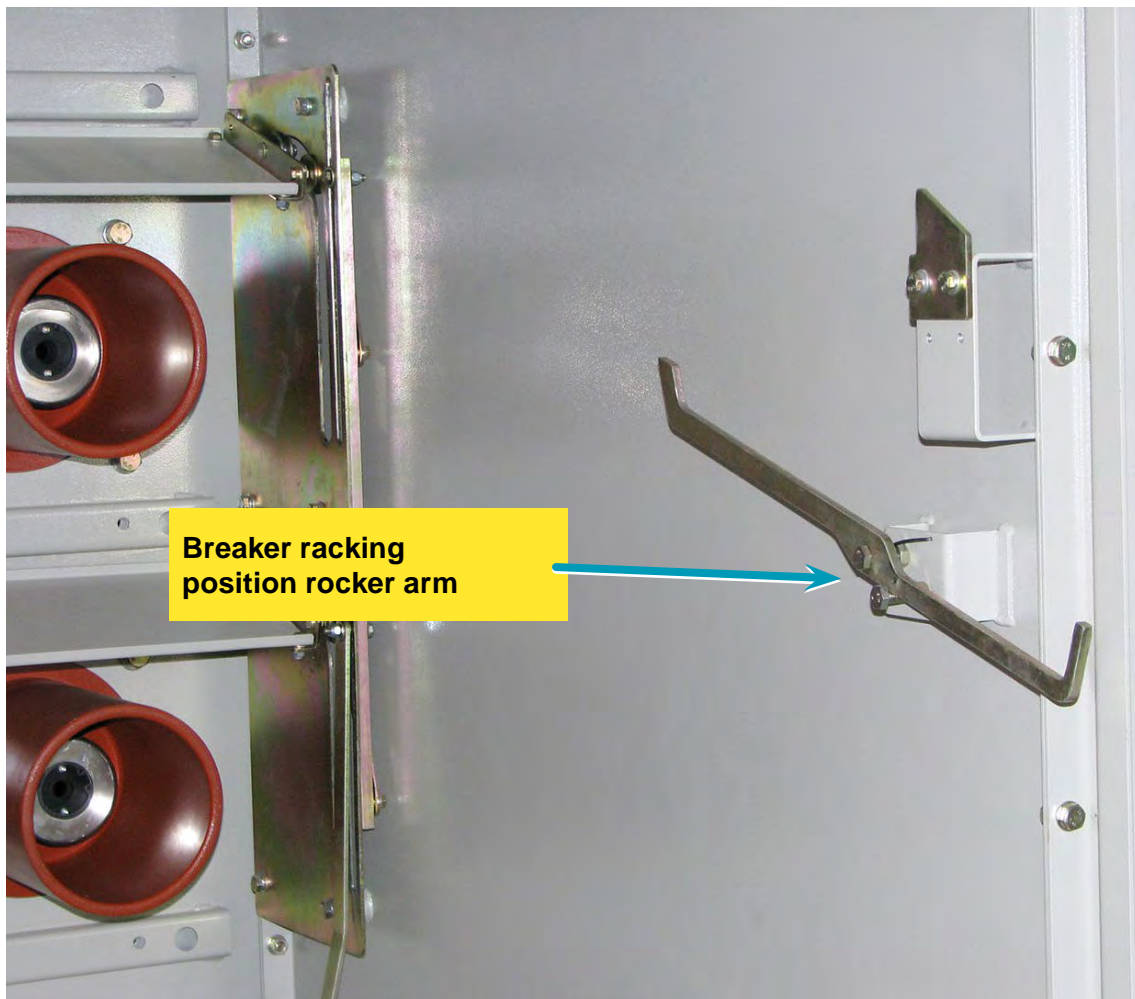

Breaker Position Indicator

If the Citadel cell is empty or the breaker is in the Disconnected position The Cell mounted Breaker Racking Position rocker-arm that moves the door mounted semaphore is in the lowered position.

As the breaker racks into the connect position – a slider pin on the side of the Citadel pushes the arm up. (Feature #12, page 56)

This arm will the move the position indicator – and can optionally seal the front door closed if desired.

FIGURE 37A

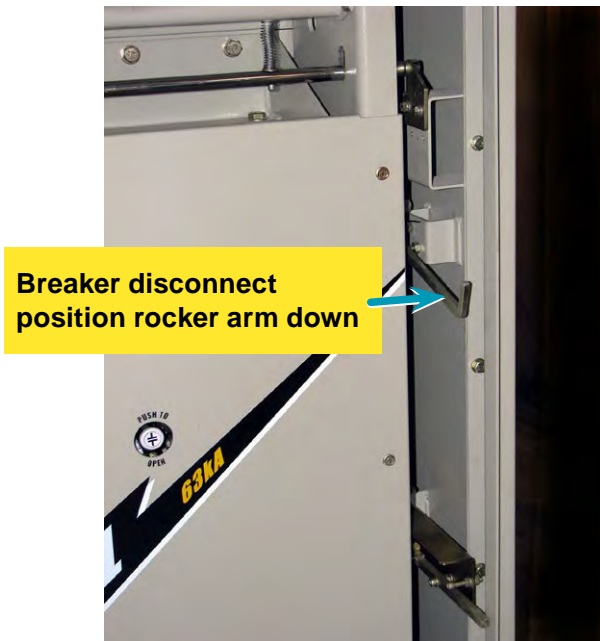

FIGURE 37B

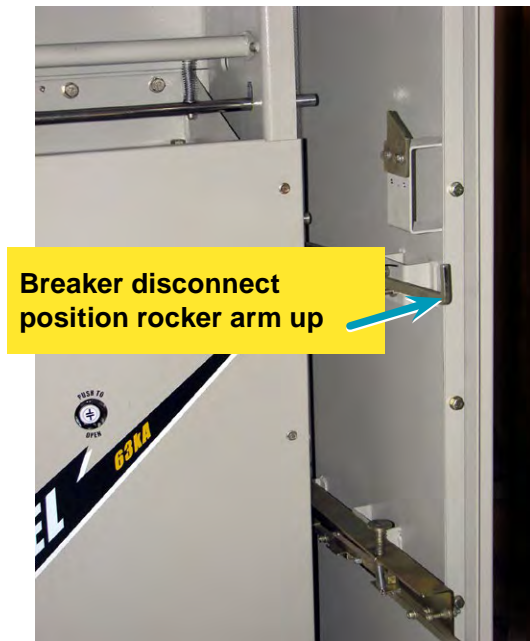

FIGURE 38A

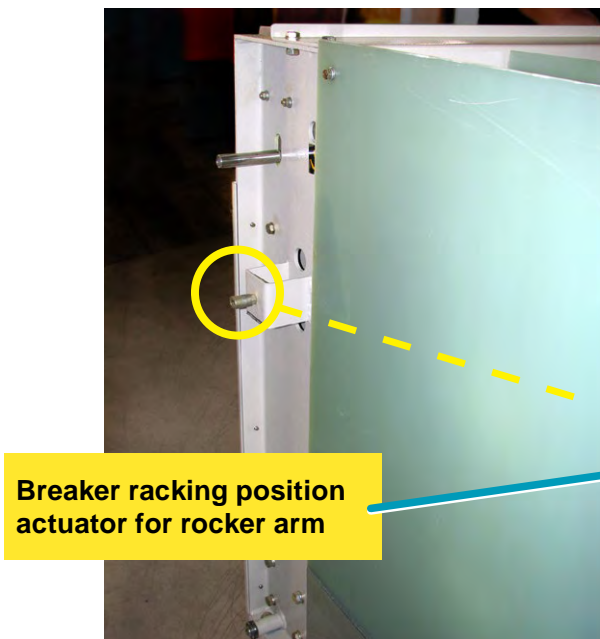
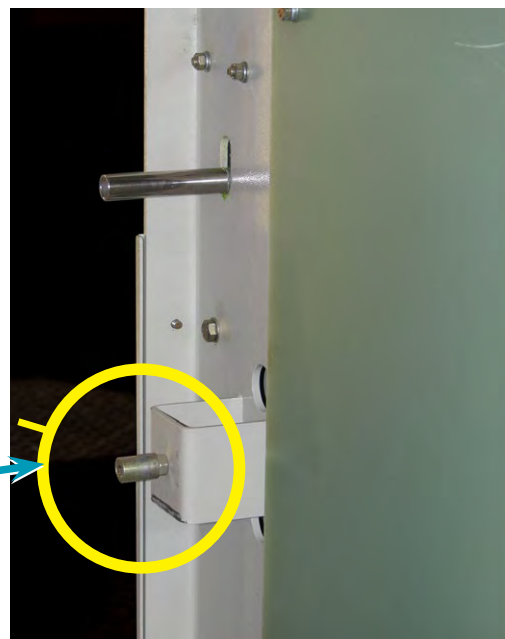

FIGURE 38B



Breaker Open - Close indication actuator for front door indication

The Citadel can uniquely let personnel know the breaker is open or closed – even if the switchgear front door is shut.

On the right side of the breaker is a cam actuator that rotates as the breaker opens and closes. (Feature #13, page 56)

The cam presses down on the actuator mechanism located on the right side of the switchgear cell wall.

As the cam forces the actuator down – the actuator slides the bracket on the inside of the cell door which in turn moves the front door indication semaphore.

FIGURE 39A



FIGURE 39B



FIGURE 40

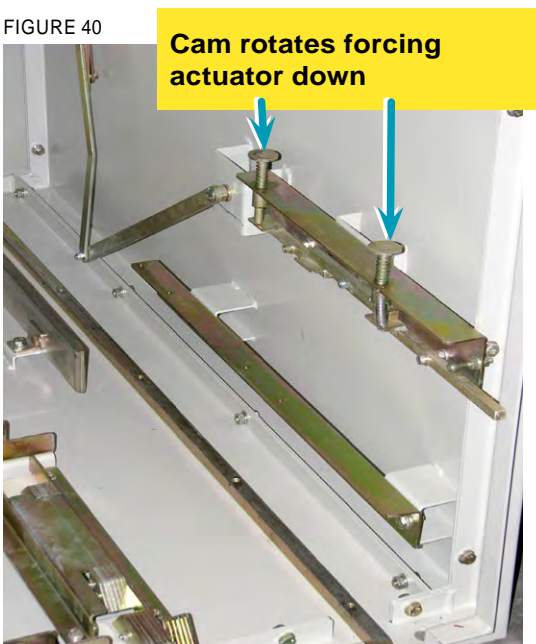

FIGURE 41



Breaker Disconnect Position Latch



FIGURE 42

Left side latch bracket

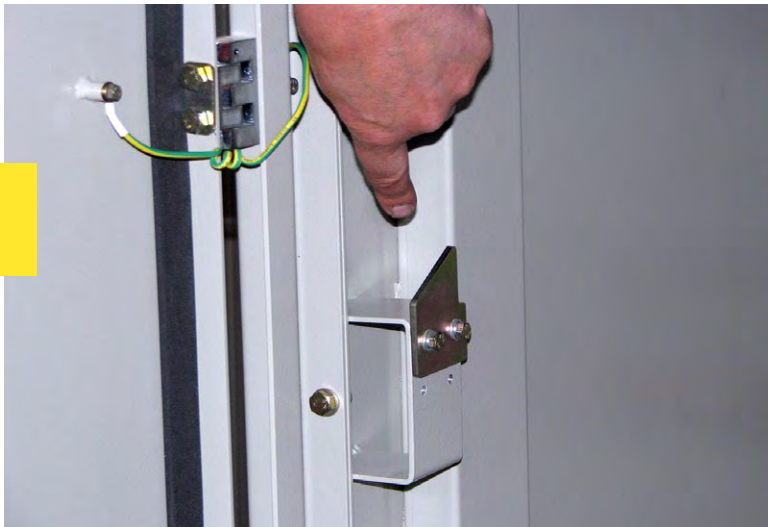

FIGURE 43

Right side latch bracket



FIGURE 44

Operating the disconnect position interlock



FIGURE 45



FIGURE 46

Citadel Disconnect vs Connect position

The Citadel's dual position functionality, enhances Operator confidence. When the racking screw spins free – the breaker is either in the Disconnect position or the Connected position.

Disconnect position



FIGURE 47

Locked in disconnect position



FIGURE 48

Connect position

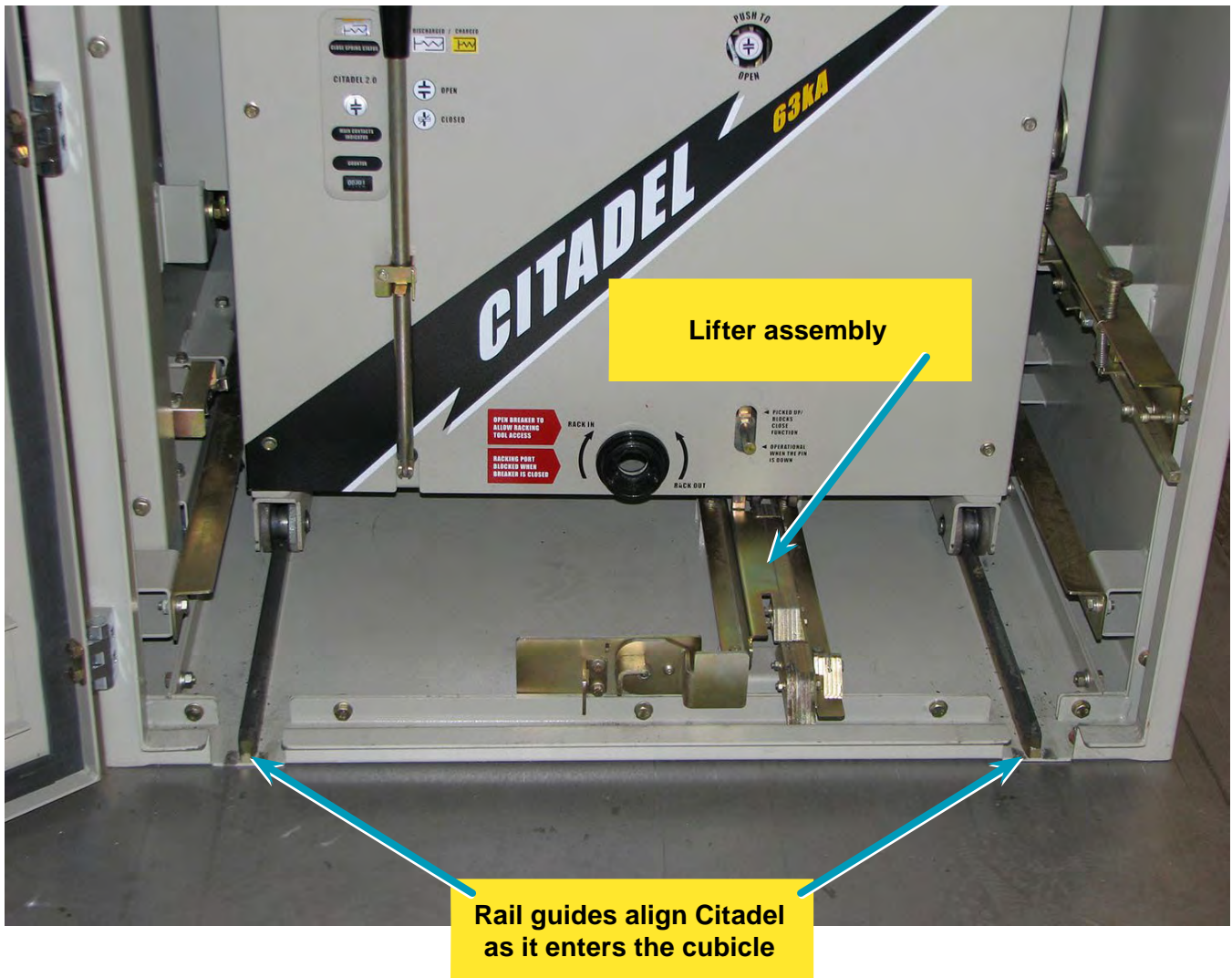

FIGURE 49

Solid steel rails

Solid steel rails guide and securely hold the Citadel's concave steel wheels as the Citadel enters, connects and exits the switchgear cell. The floor mounted lifter assembly keeps the Citadel in a “tripped” and “block the close” condition for all positions other than fully Connected and fully Disconnected. Additionally the floor mounted lifter assembly will discharge the Closing Spring when the breaker enters or exits the switchgear cubicle.

FIGURE 50



Floor Lifter for breaker paddles

FIGURE 51

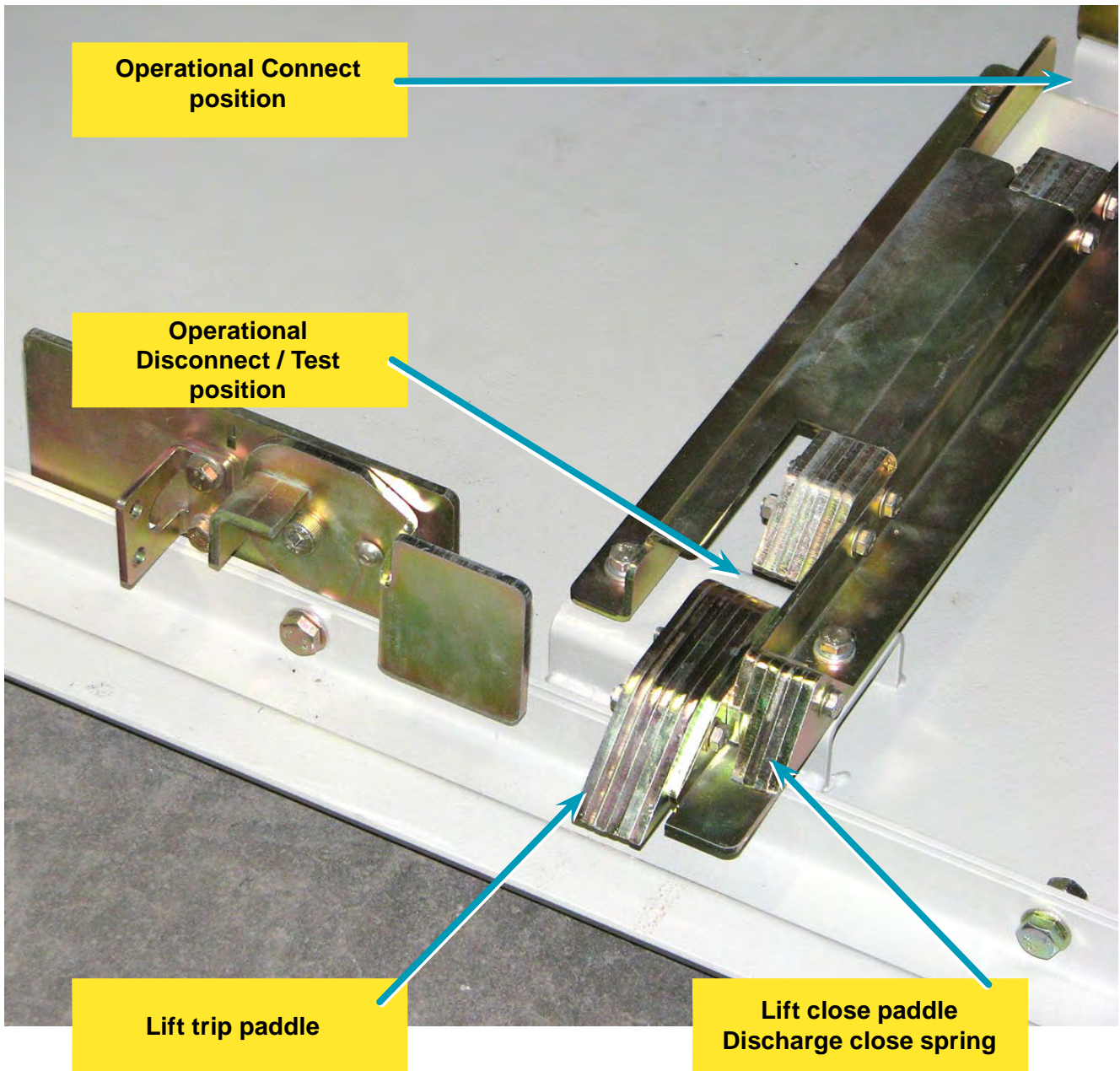

Close & Trip Rollers and position indication pin

Close and Trip rollers are actuated by the lifter plate on the switchgear floor. The location indication pin will only fall into the lifter plate slots in the Disconnect and Connect positions, providing a permissive operation. For all other locations of the breaker within the cubicle the Citadel must and will be tripped open and the close function blocked.

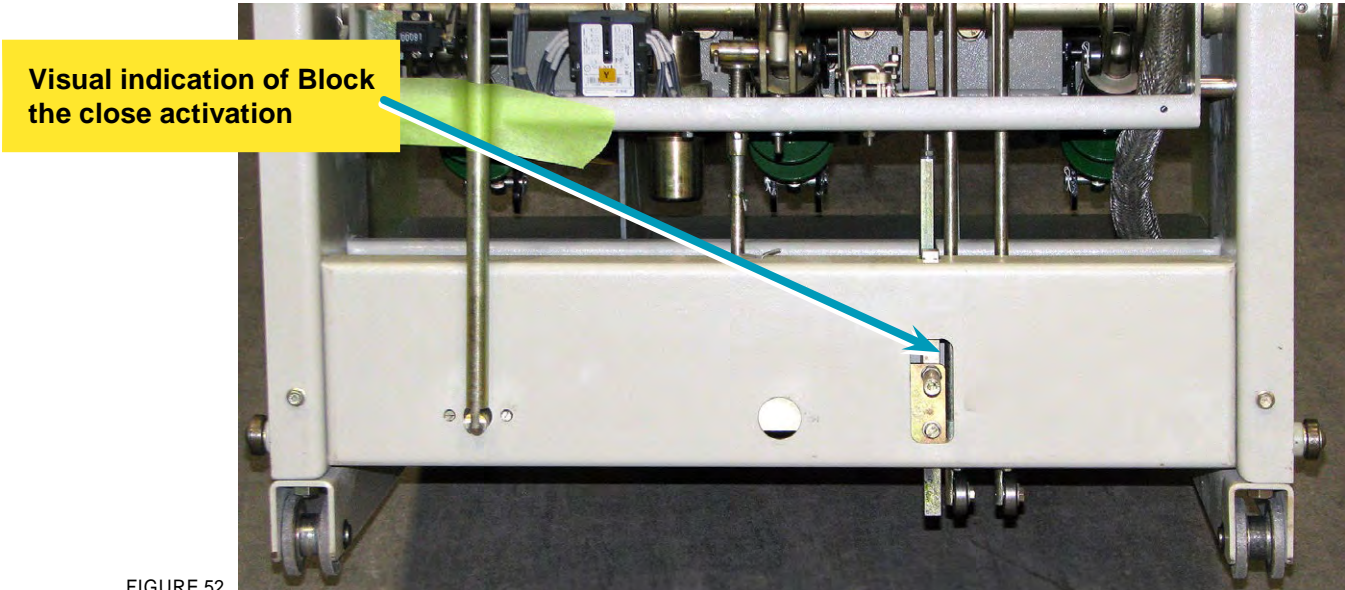

FIGURE 52

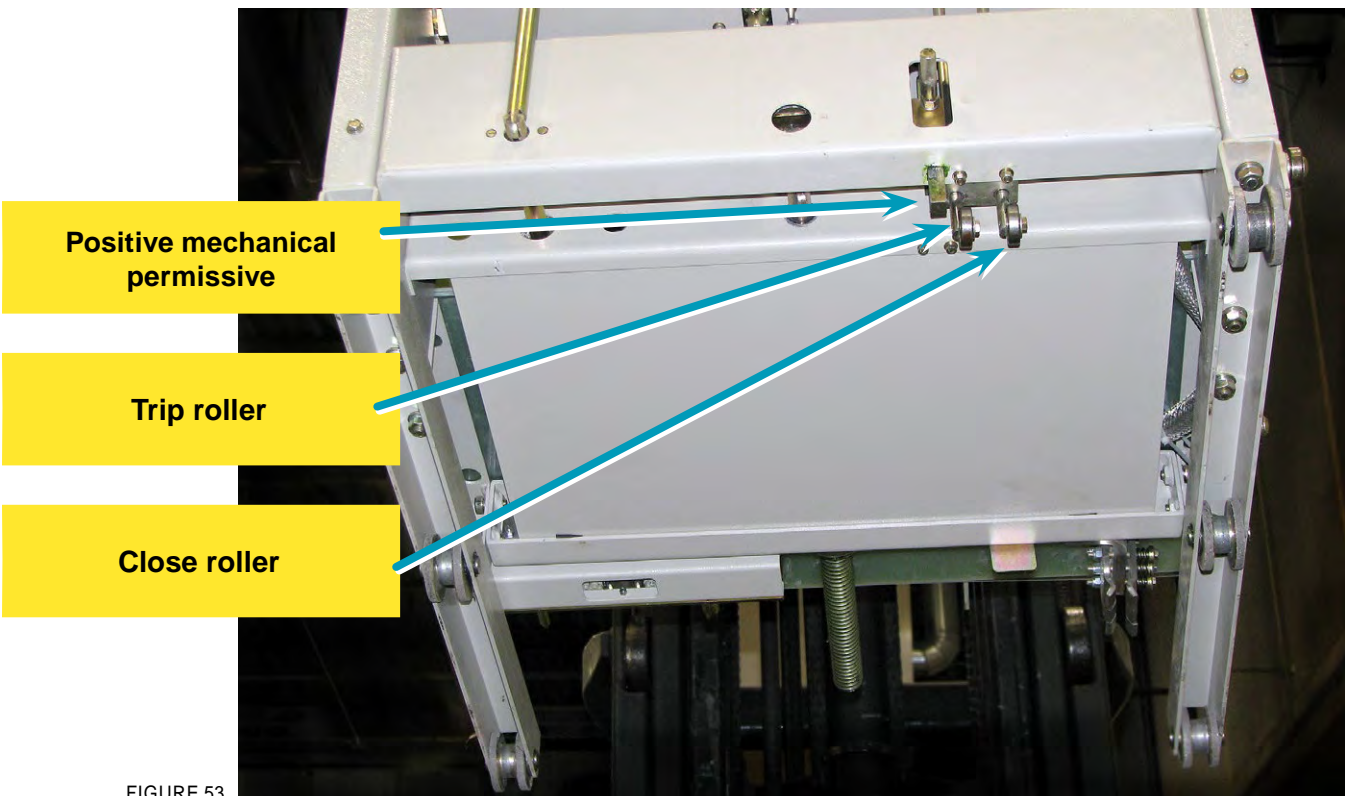
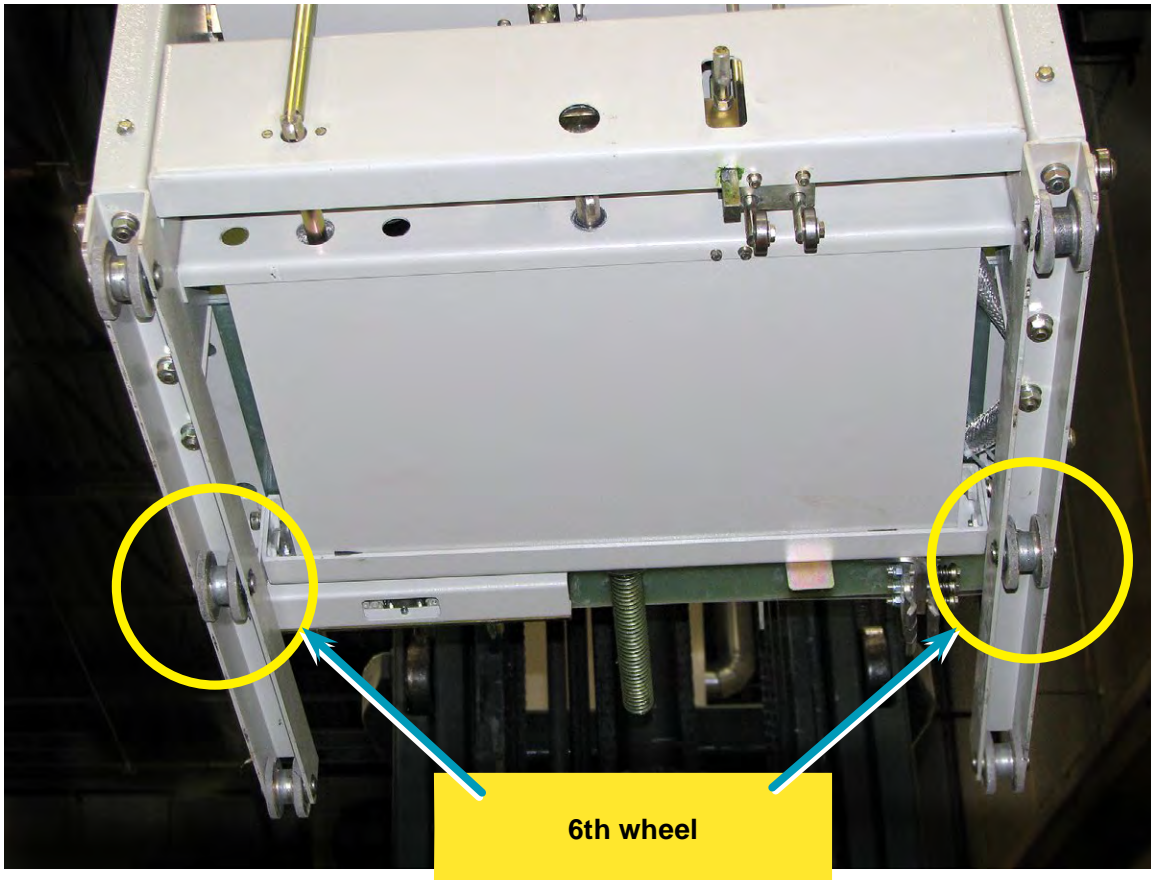

FIGURE 53

6th wheel.

The Citadel carriage employs a 6th wheel configuration for ease of mobility when the breaker is removed from cubicle

FIGURE 54



Breaker retention brackets

Two heavy duty rollers on both the left and right of the Citadel roll directly under the cubicle's breaker retention brackets. Under severe fault conditions Citadel breakers remain secure in all three planes.

FIGURE 55

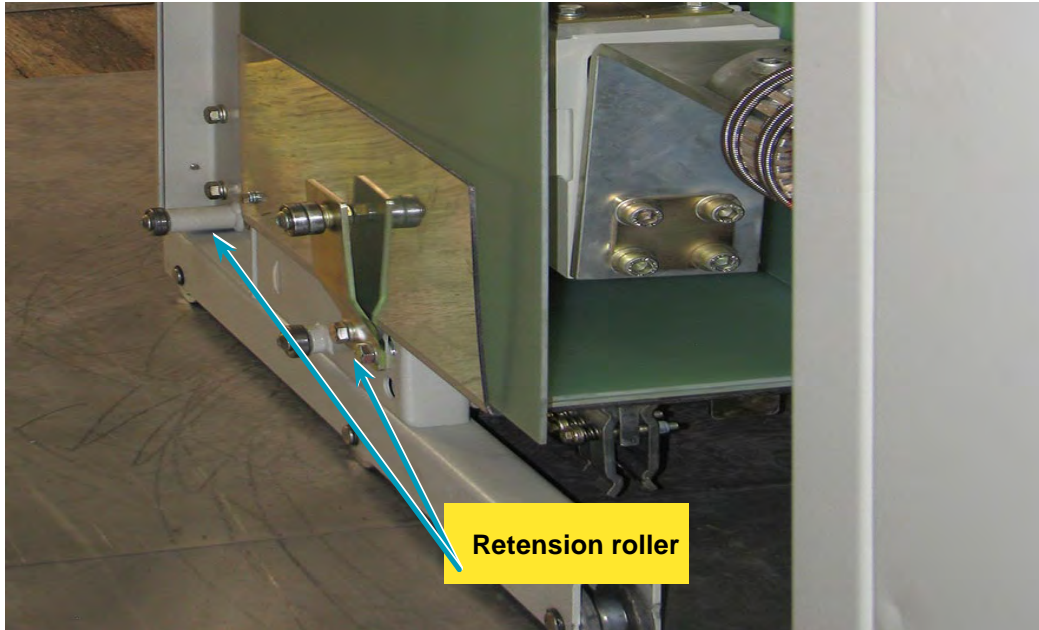
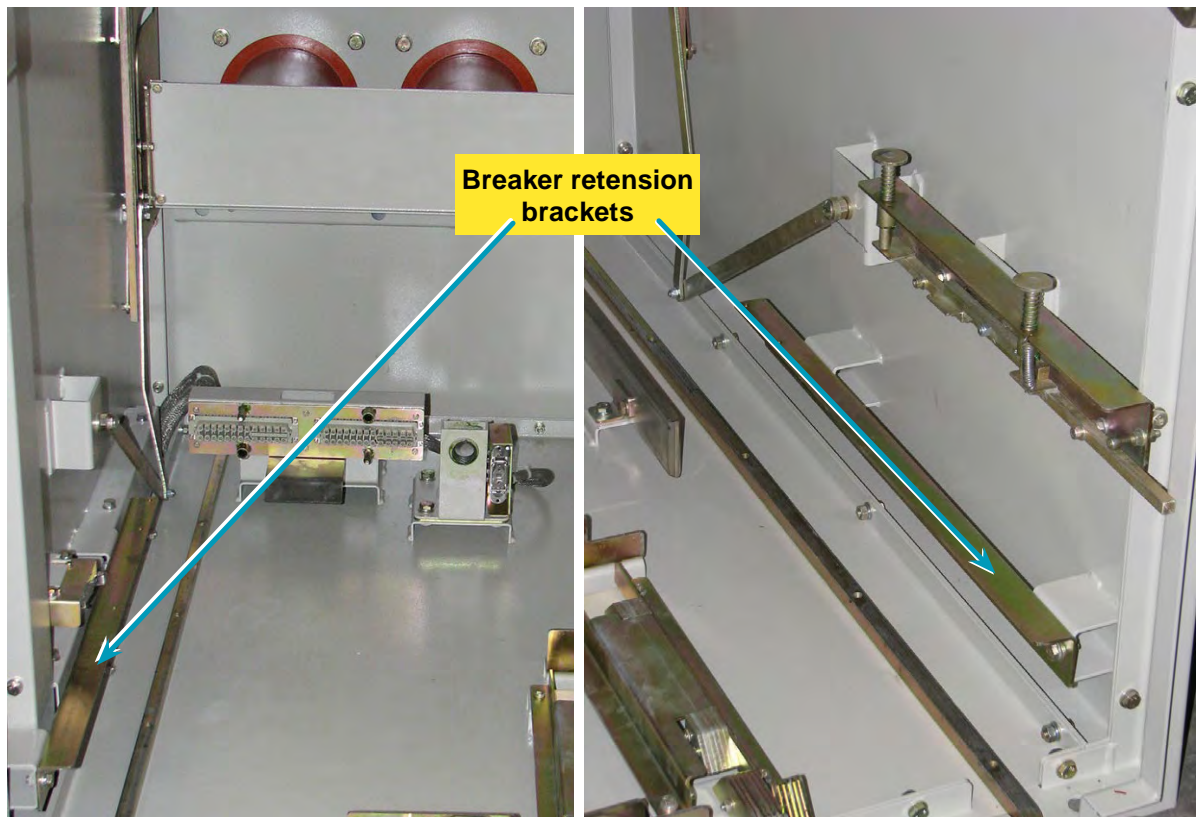

FIGURE 56

FIGURE 57



Stationary Racking Nut

The Citadel racking system is simple, rugged and guided by safety. More information can be found in the section on breaker racking.

FIGURE 58

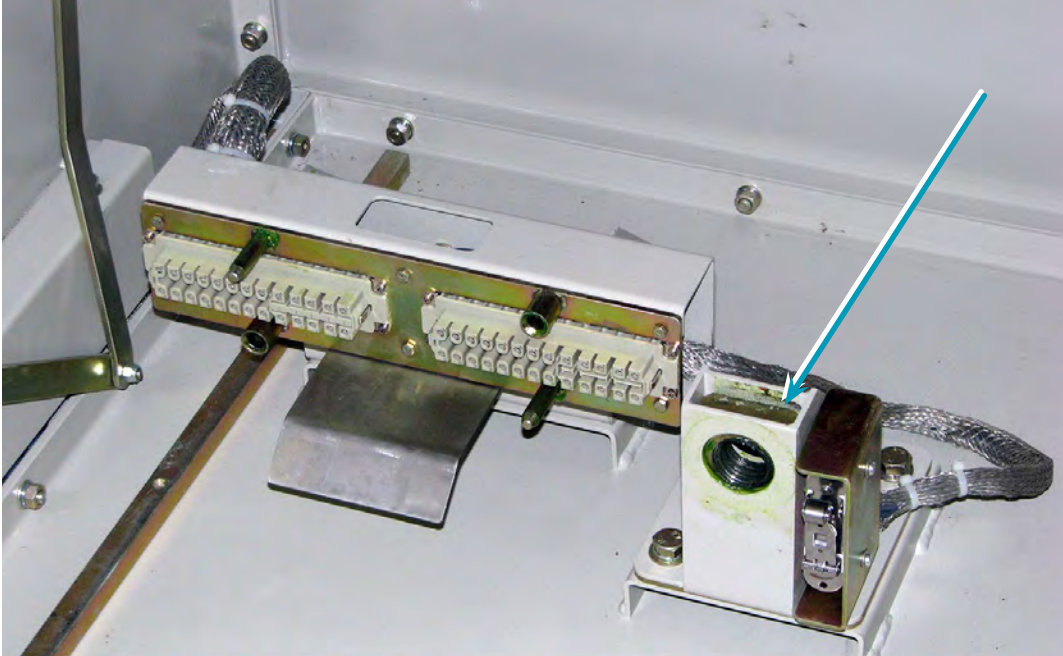
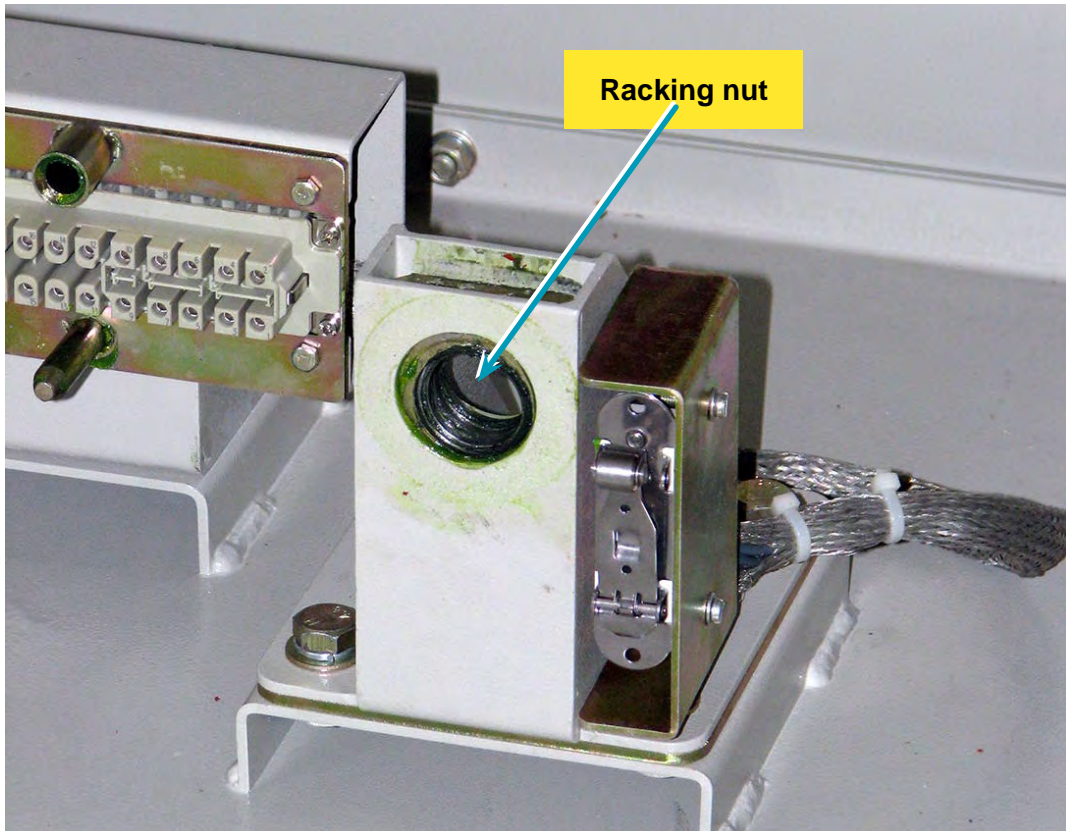
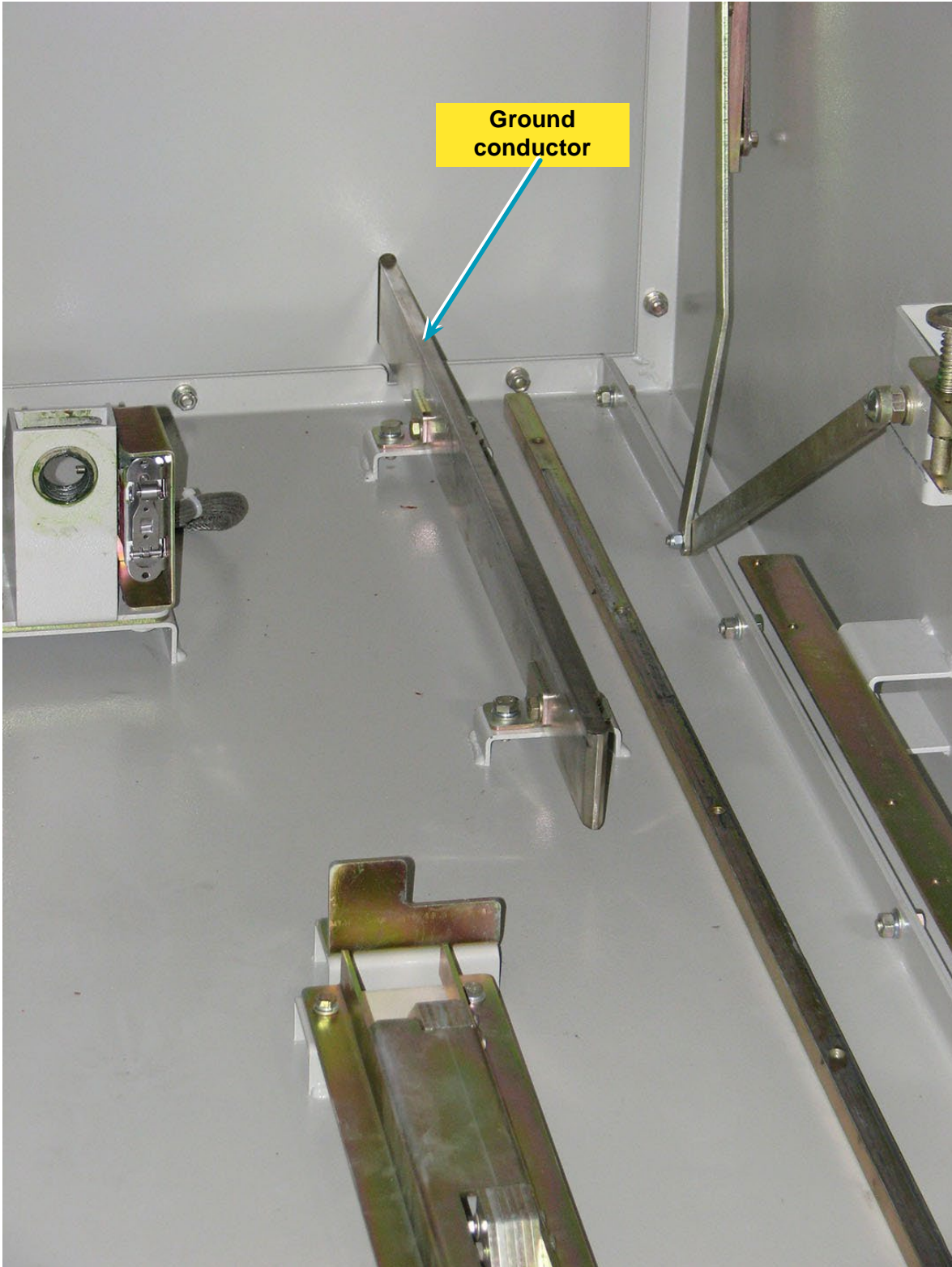

FIGURE 59



Stationary copper ground conductor - Silver plated Copper 2.375 x 0.5"

FIGURE 60



TOC # 1 – Provides electrical indication that a breaker is in the cubicle in the Disconnect Position 2NO+2NC

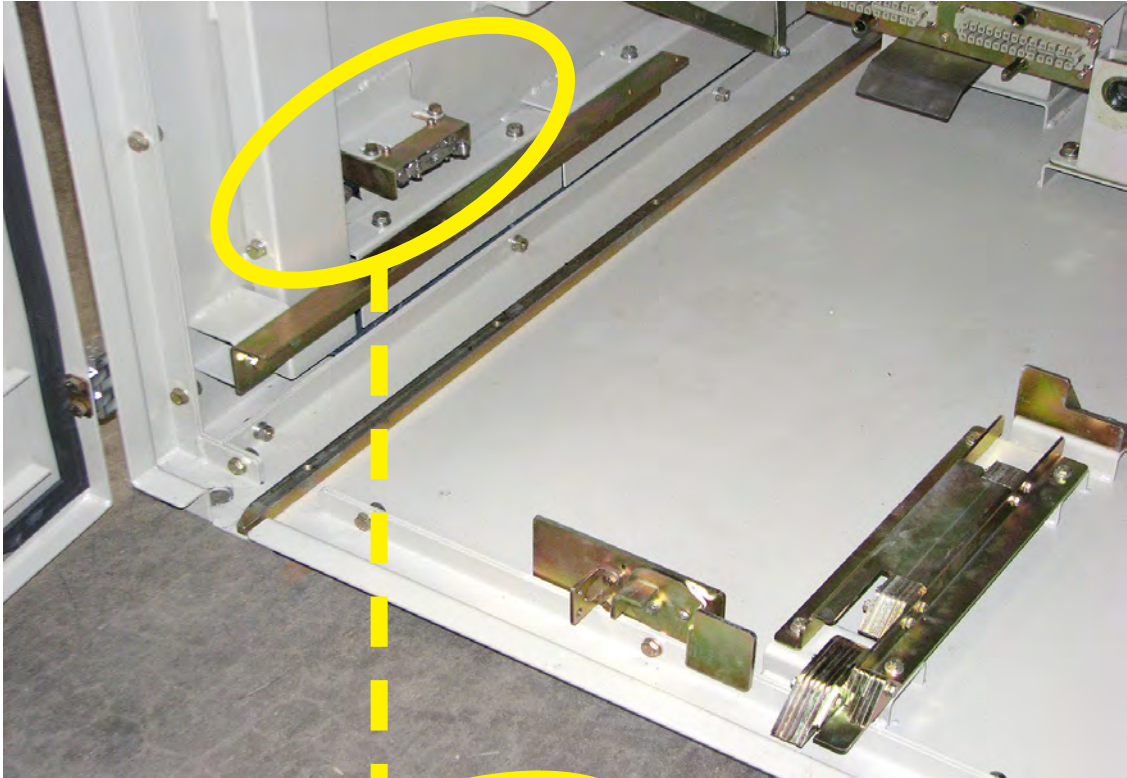

FIGURE 61A

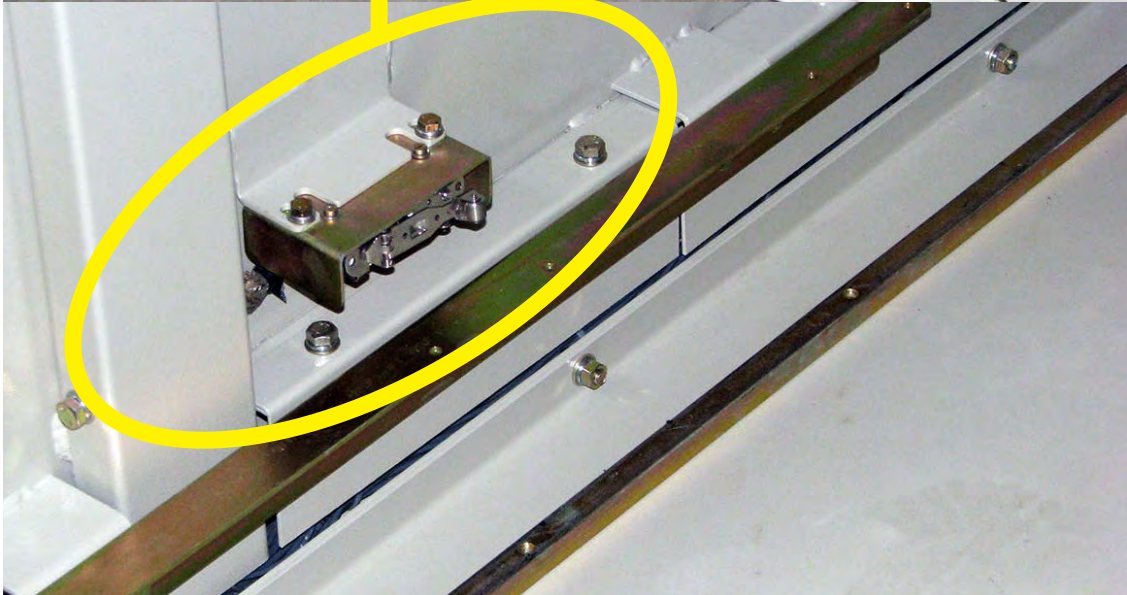

FIGURE 61B

TOC # 2 – Provides electrical indication that a breaker is in the cubicle in the Connect Position 2NO+2NC

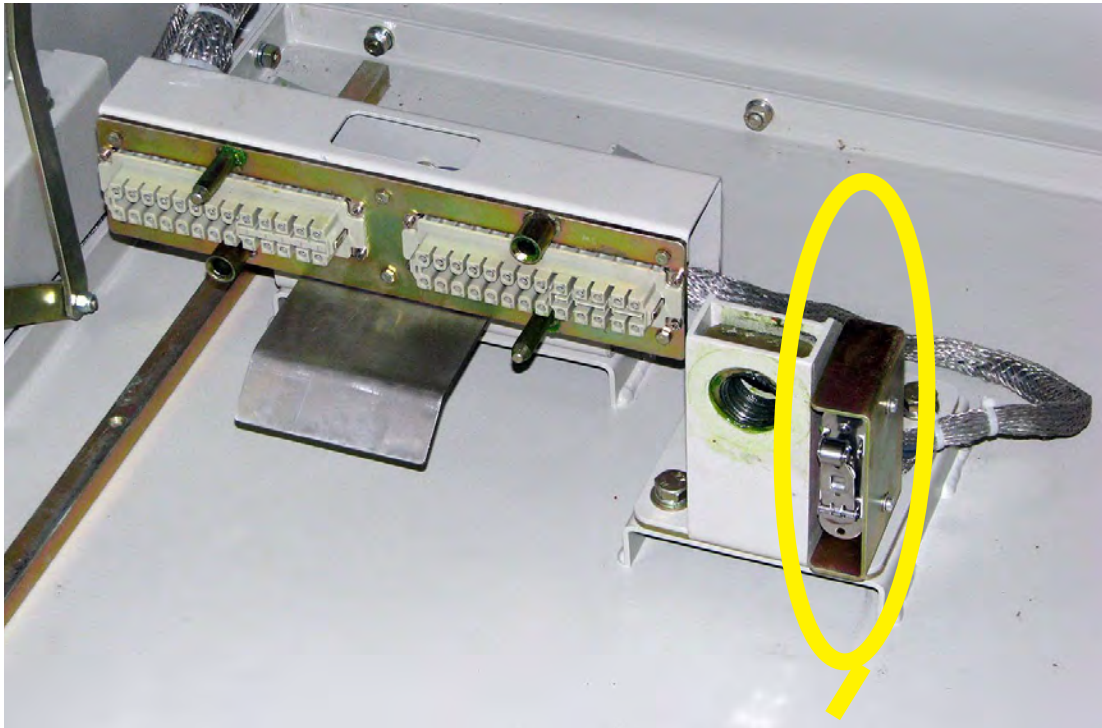

FIGURE 62A

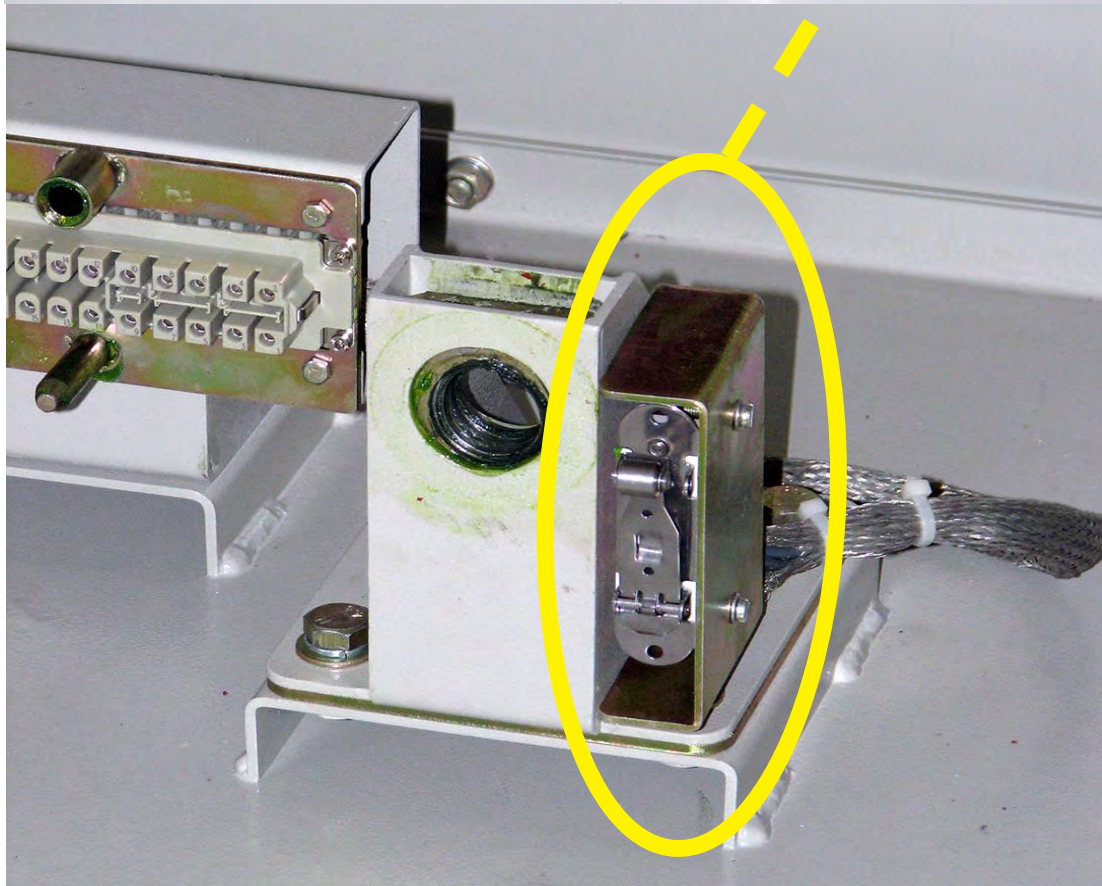

FIGURE 62B

Citadel in Disconnect position

FIGURE 63



The moving secondary block frame is mechanically connected to a secondary slider batton on the front of the Citadel breaker. This “slider batton” allows the moving contact block to manually be pushed rearward and thereby connect with the stationary cell side. This action allows a breaker in the “disconnect” position to be placed into a “Test” position. The breaker can now be operated electrically and mechanically. All secondary control auxiliary connections will make and break as though the Citadel breaker was in the fully connected position.



FIGURE 64

Secondary slider batton

Engaging the Test position

To place Citadel in Test while in the Disconnect position – simply release the secondary handle latch, move handle to a horizontal position – give a smooth lateral push on the handle to seat the moving secondary connector pins into their stationary cell counterparts.

FIGURE 65

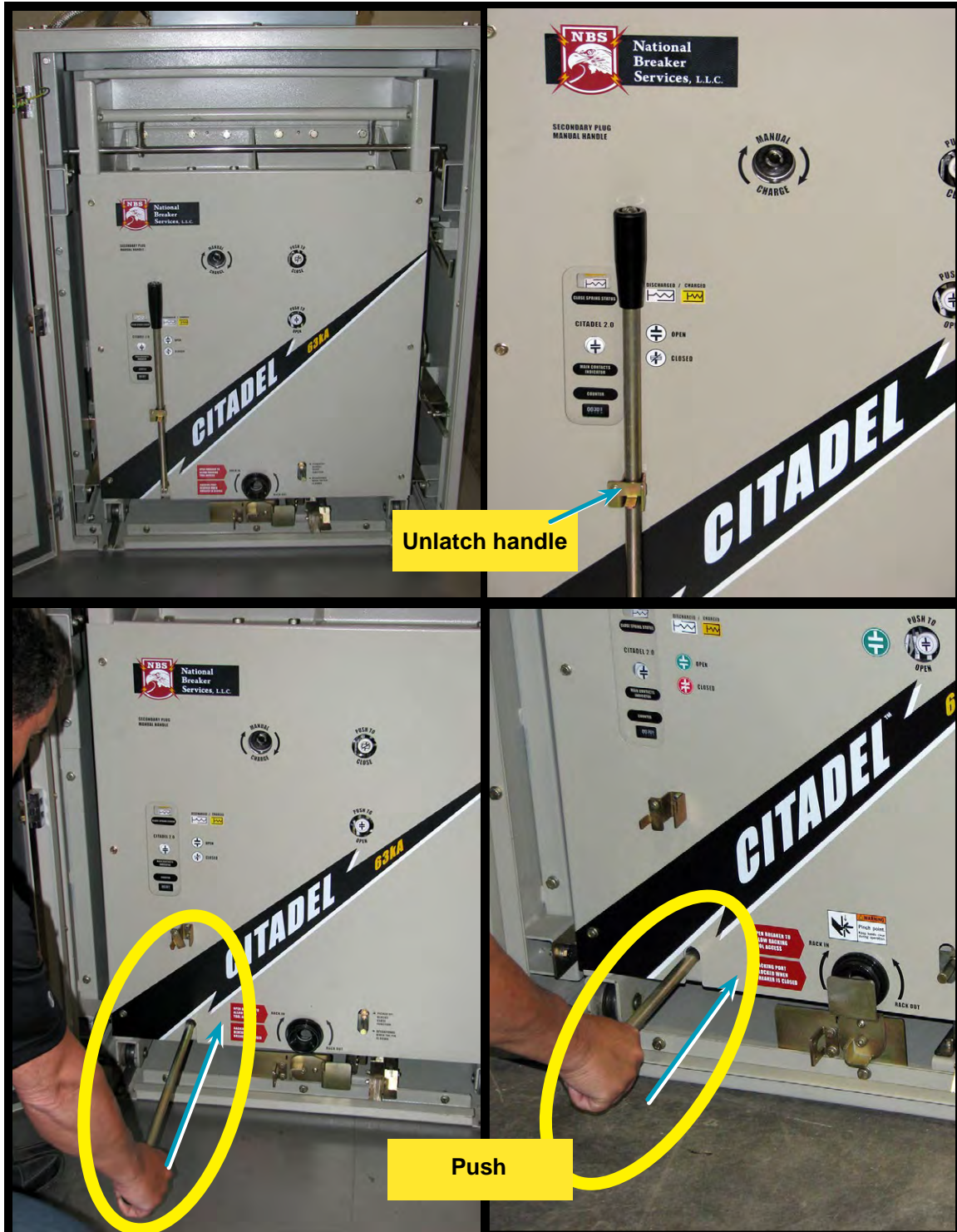

Dis-engaging secondaries

The Citadel secondary batton handle incorporates a leveraging upper section to assist in the dis-engagement of secondary contacts. (See video after QR code scan)

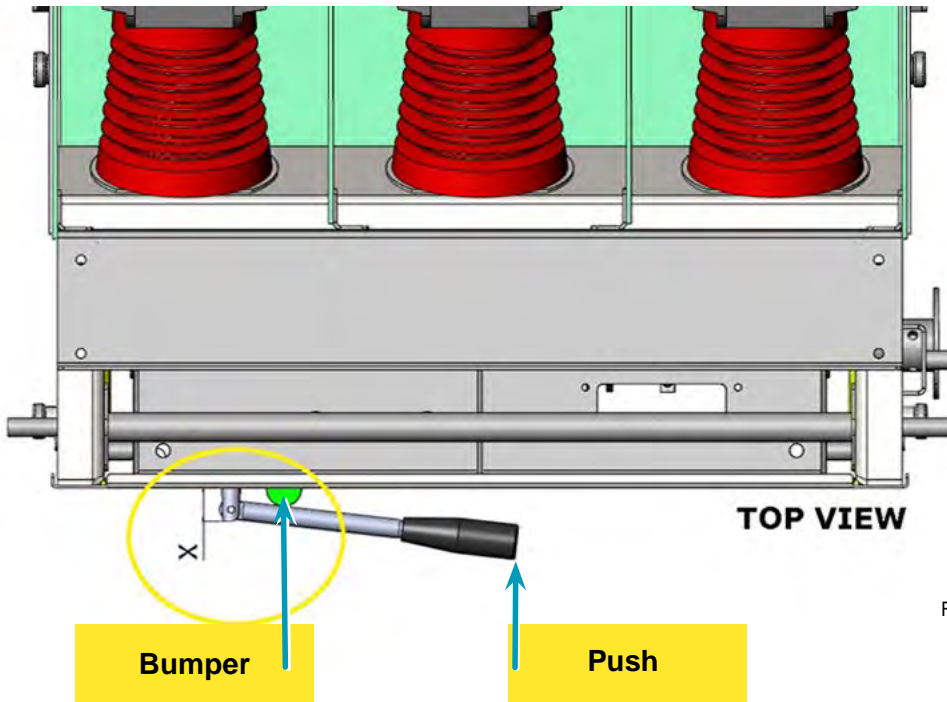

FIGURE 66A

Bend upper most section of batton handle and apply modest pressure against the bumper

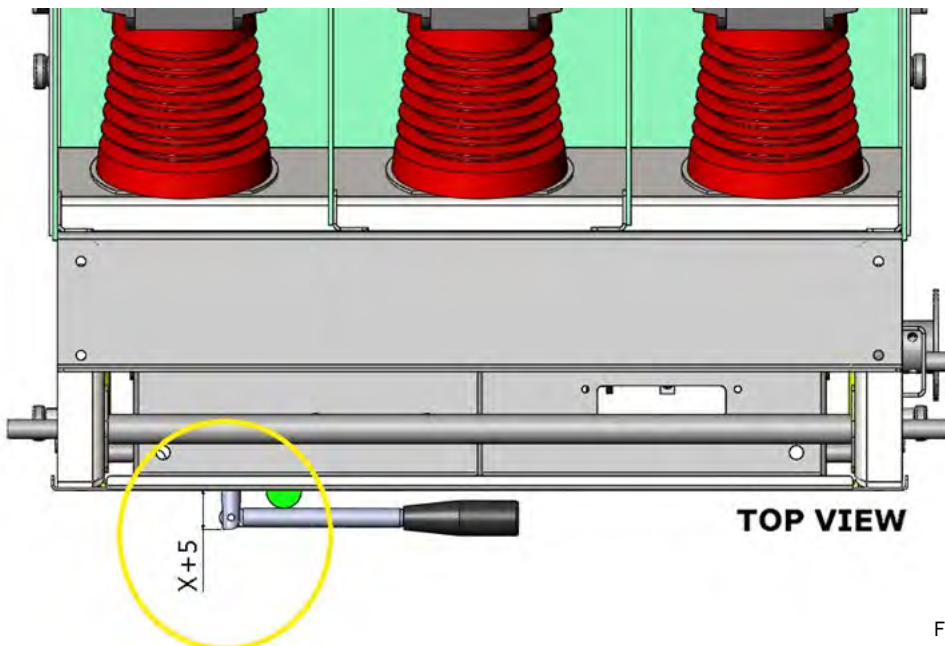

FIGURE 66B

Breaker position lock (often a (Kirk) Key type lock is used)

Optional Breaker position lock (often employing a kirk type lock) prevents breaker from being racked and can release a key for sequencing

FIGURE 67A

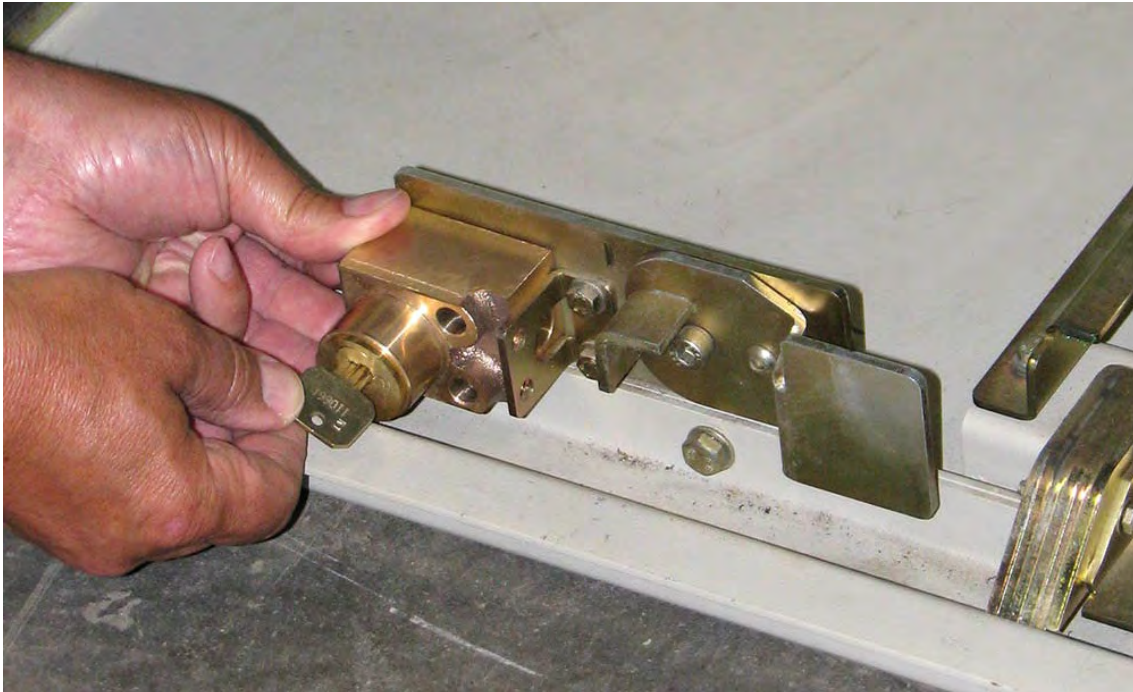
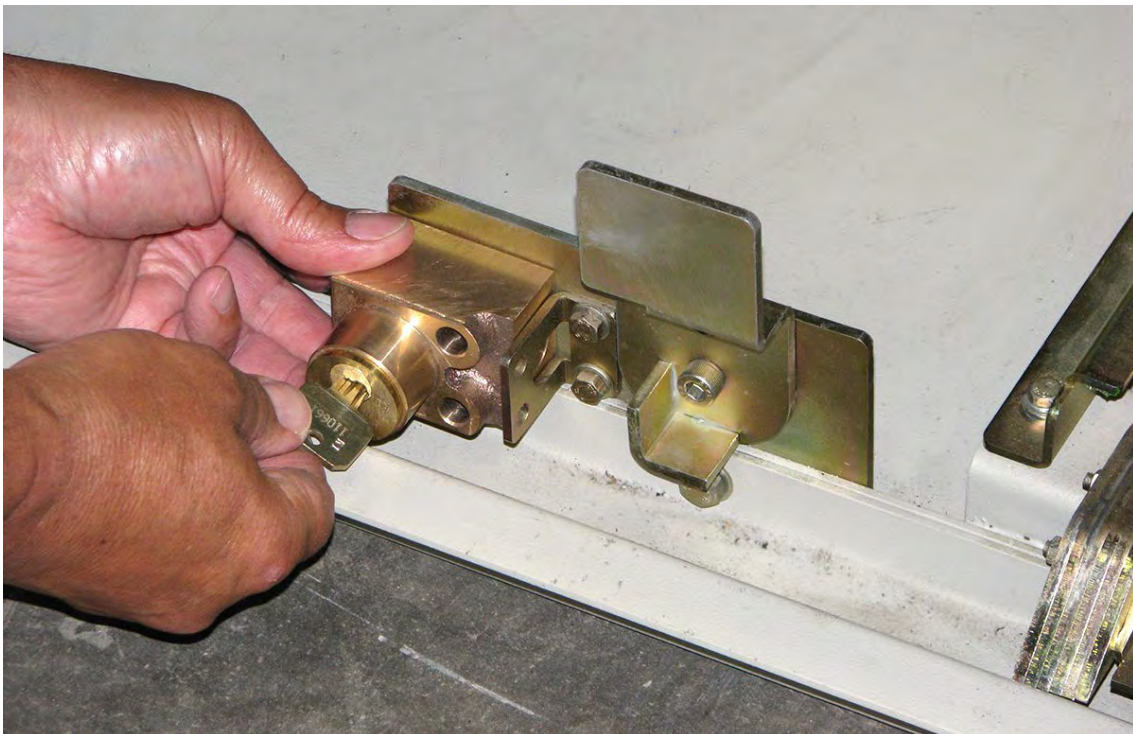

FIGURE 67B



Shutter arm actuators

The Stationary Primary Disconnects are covered by grounded metal shutters when the Citadel is in the Disconnected Position or the cell is empty. Rollers on the lower right and left sides of the Citadel move underneath and uniformly lift the shutter arms for smooth positive operation.

FIGURE 68

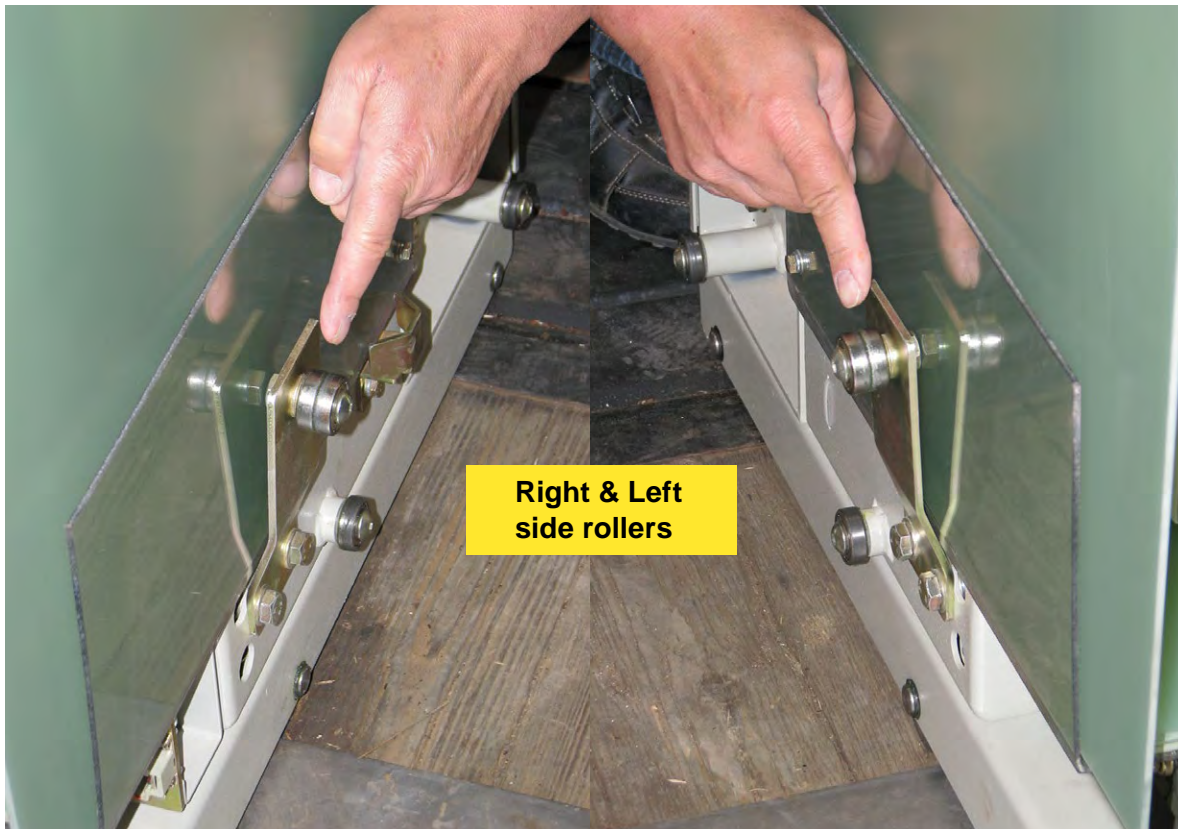

Shutter lifting arms

As the Citadel racks into position - a roller on each side of the Citadel carriage lifts the right and left shutter arm assembly to access the primary disconnects

Grounded metal shutters

Metal shutters operated by a dual arm lifting system, move smoothly and securely within a positive guideway on both sides of the switchgear cubicle

FIGURE 69

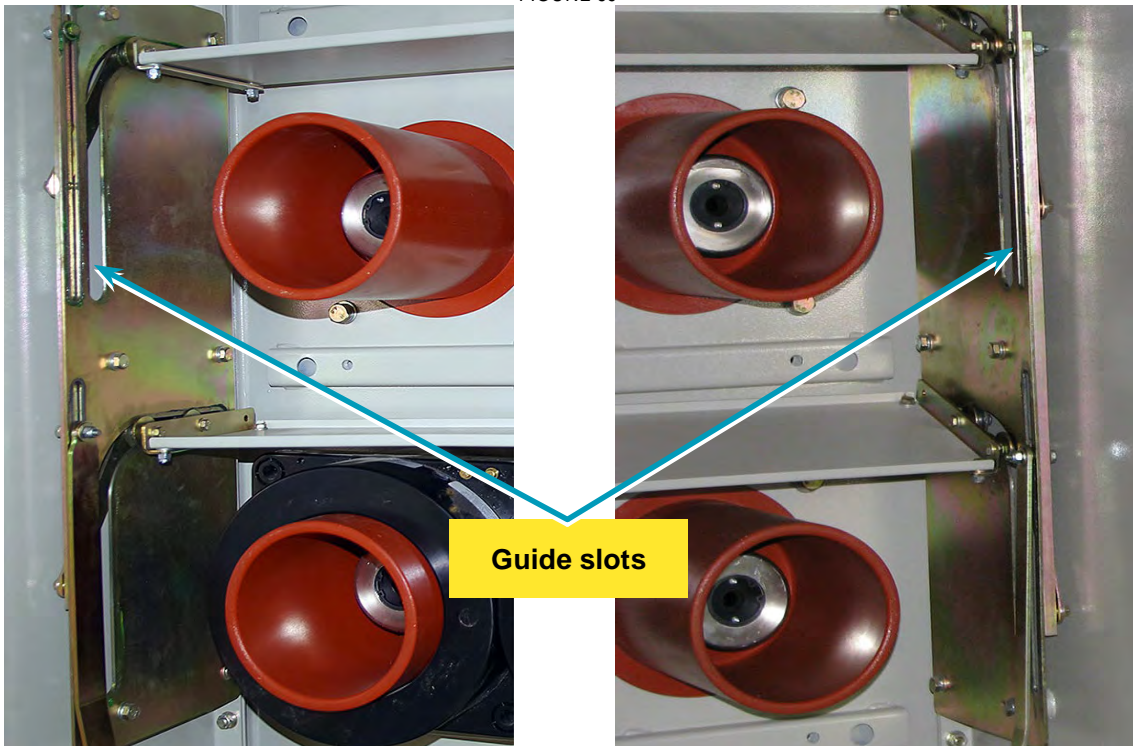
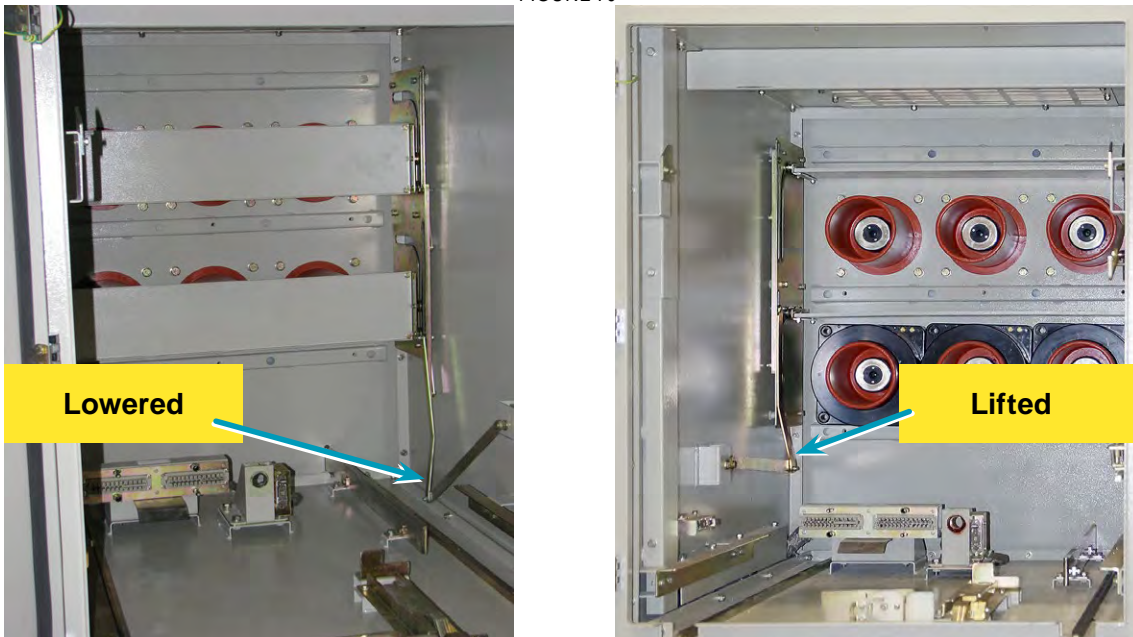

FIGURE 70



Stationary Primary Disconnects

Primary Disconnects have large silver plated copper conductor with finger cluster guide pin recesses (for 63 kA).

The Primary Disconnect bottles can handle multiple CT configurations

FIGURE 71



Stationary Primary Disconnect bus connection pad

The bus connection pad on the rear of the stationary Primary Disconnect conductor has a large surface area and multiple threaded bolt-holes to insure a good conductive connection

FIGURE 72

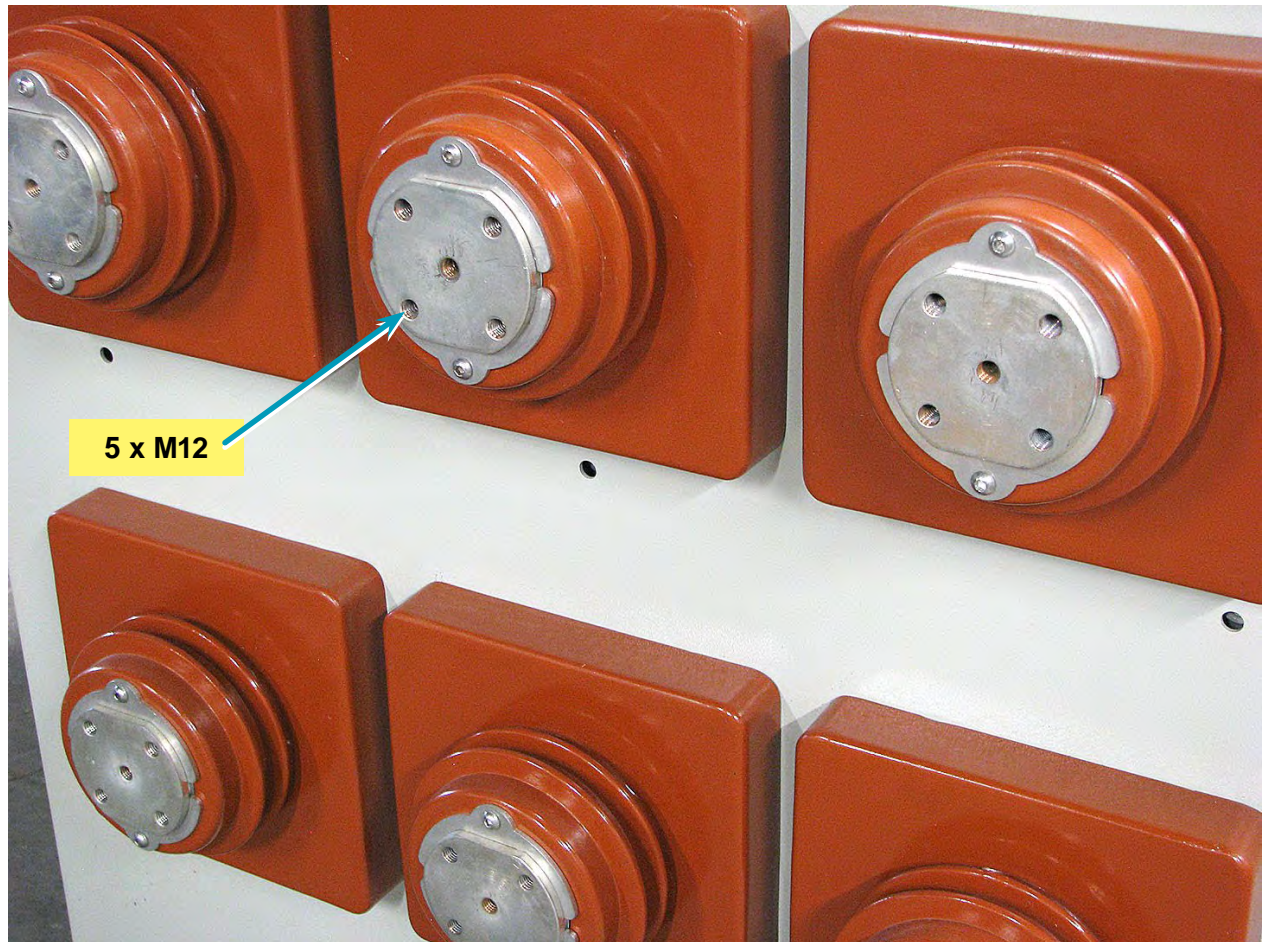

Moving Primary Disconnect Assemblies

I.e. Finger clusters - are always conservative and rated for surface area and spring pressure.



FIGURE 73

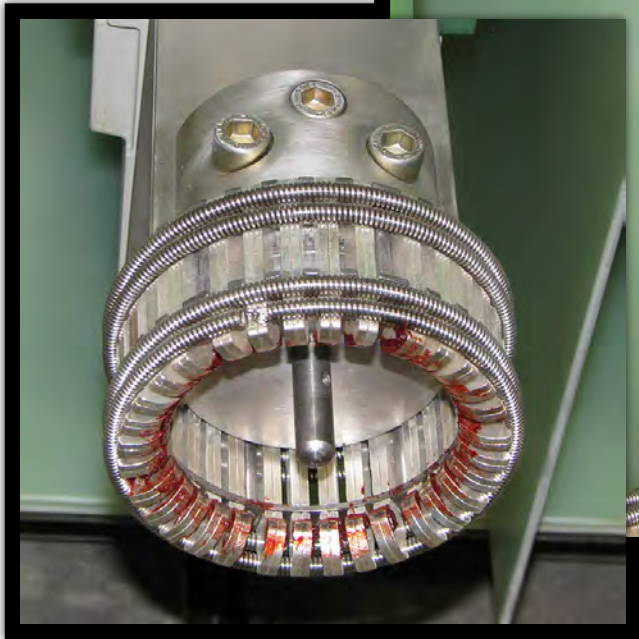
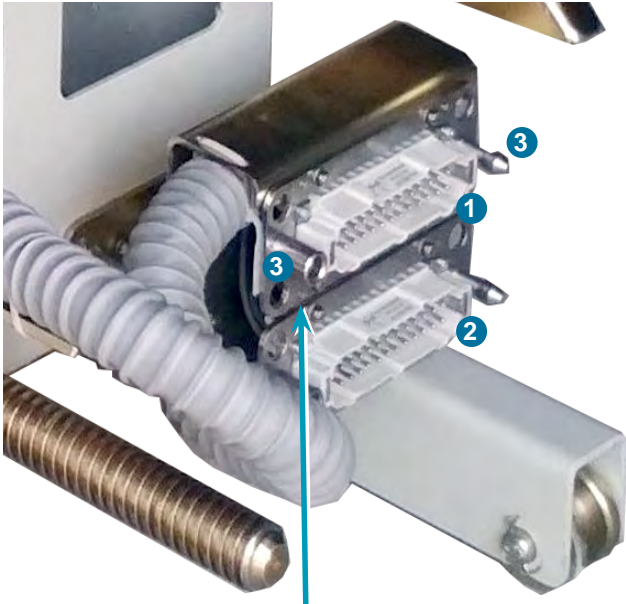

FIGURE 74A



Moving Secondary Contact Assembly

Secondary contacts are one above the other for 26 inch wide switchgear

FIGURE 74B

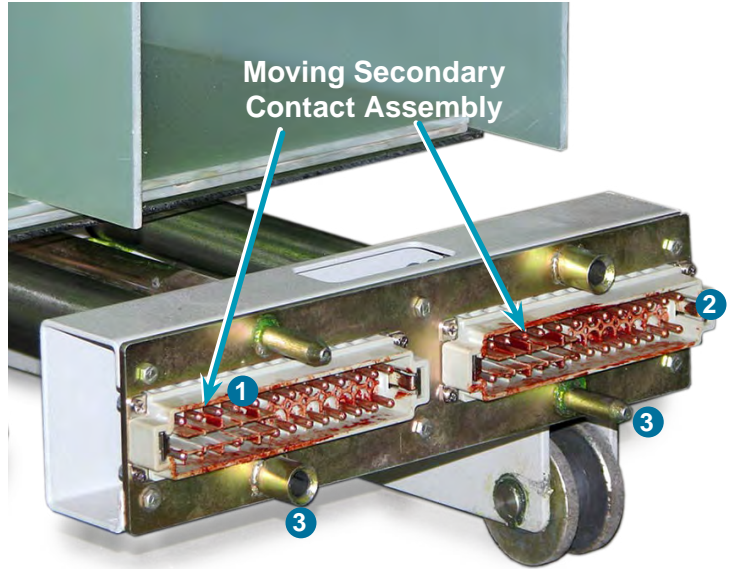

Secondary contacts are side by side for 36 inch wide switchgear

The **moving & stationary** secondary contact block frame assemblies are rugged mounting frames for holding the secondary male and female contact block(s). These rugged mating frames provide positive alignment between the two halves. The moving assembly is mounted on the lower right hand side of the breaker carriage when looking at the breaker from the rear and holds the male contact block(s). The stationary assembly is mounted on the lower left hand rear side of the switchgear cell when looking at the cell from the front and holds the female contact block(s).

The moving secondary block mounting frame has four large alignment devices two Pins and two Ports (#3 - photos above) that have their interface opposites on the cell's stationary coupling side. These coupling alignment Pins & Ports provide positive positioning of the two halves as they approach and engage each other for final electrical connection.

As the Citadel breaker is fully racked into the connected position - the two halves of the secondary contact block assembly (moving and stationary) will automatically engage with each other and make up the various control circuits designed into the switchgear assembly.

Screw type terminals hold the secondary wiring securely in the contact block. Wiring is enveloped in a flexible grounded metal mesh shroud. This provides protection and allows the movement of the secondary wiring as may be needed.

The **moving & stationary** secondary contact block frame assemblies will have one (1) set of secondary contact blocks as standard (#1 - photo above) and an optional set on the cell side when the B-MOC option is purchased (#2 - photos above).

Stationary Secondary with optional B-MOC

Stationary secondary contact block

Block “A” provided standard (motor charge – open signal – close signal + 2a and 2b auxiliary contacts). Block “B” optionally provided for B-MOC (Better-Mechanism Operated Cell switch). An additional 4 NO + 4 NC + 1 Form C contacts & a Form C contact for the latch check switch indication.

FIGURE 75

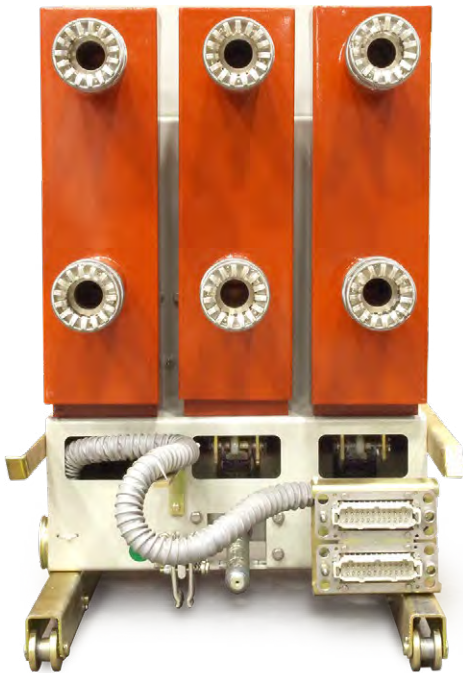

FIGURE 76

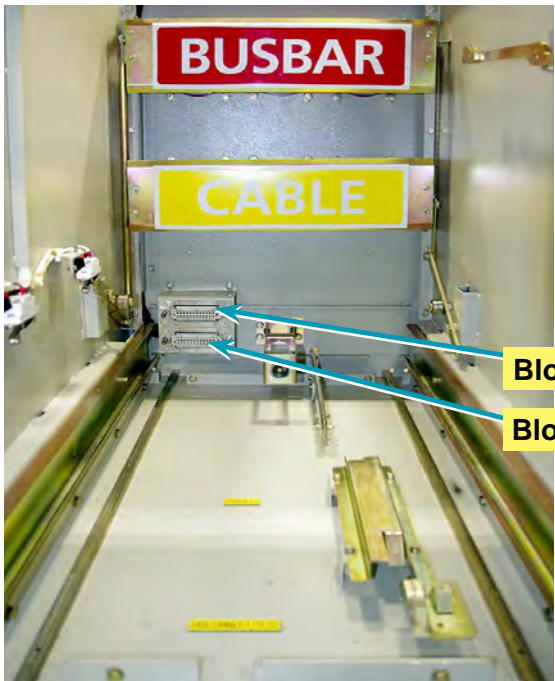

FIGURE 77

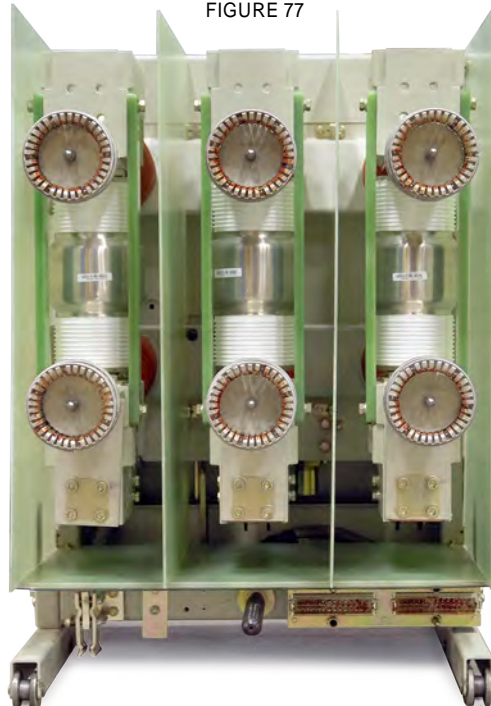

FIGURE 78

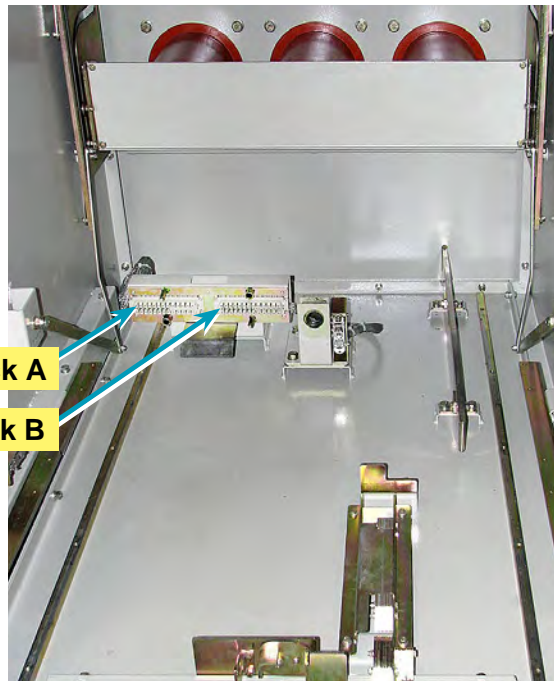

FIGURE 79

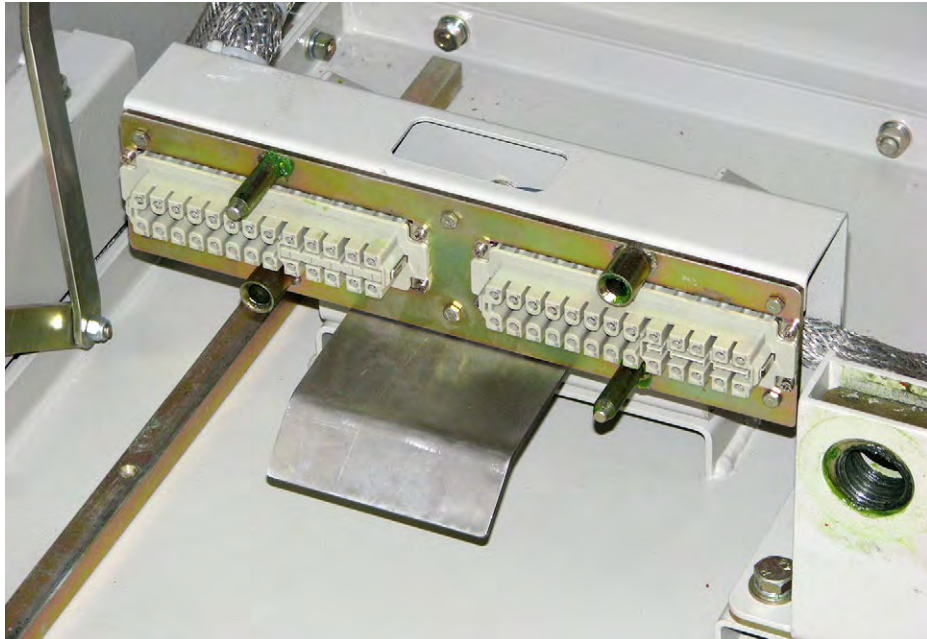
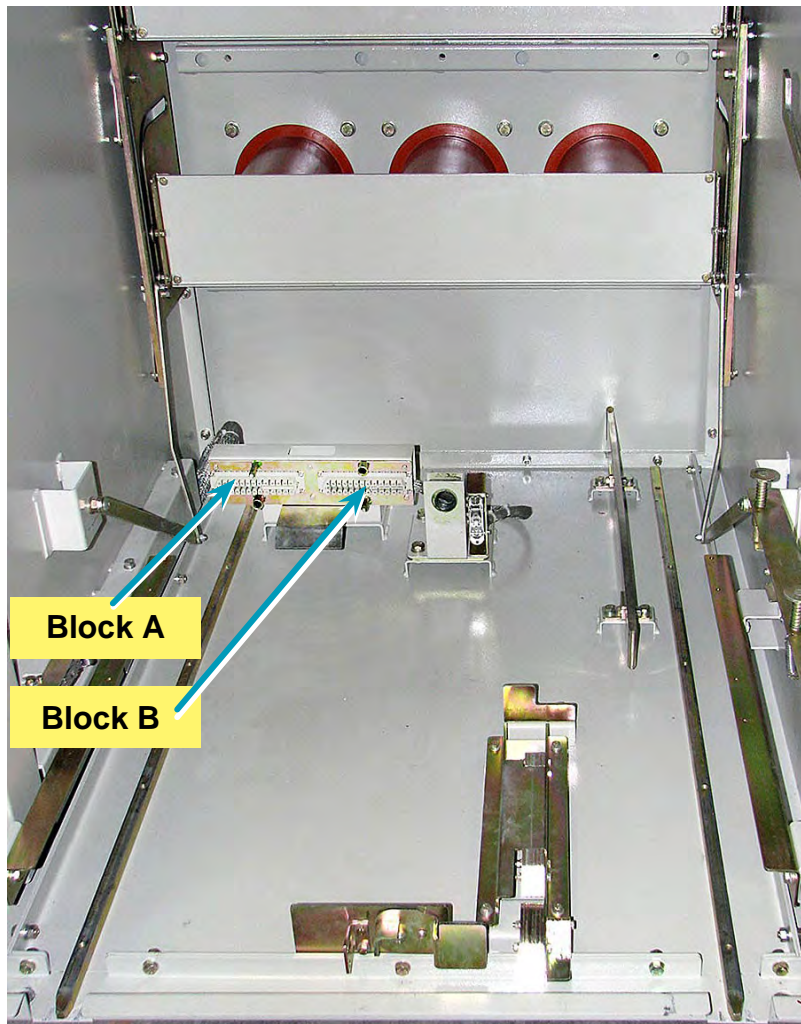

FIGURE 80



The male moving secondary contact blocks contain twenty-six (26) pins which engage with female counterparts on the stationary (cell) side.
 Factory wiring uses 14 gauge SIS wire.

The circuits are conservatively rated at a maximum of 250 V AC/DC and 10 amps.

See Control Wiring diagrams for the pin out functions associated with each wiring point.

Contact the factory to optionally obtain extended voltage and current ranges on control circuit.

Technical Specifications Secondary Control Contact Block Assembly;

FIGURE 81



Female - switchgear/cubicle (stationary)



Male - breaker side (movable)

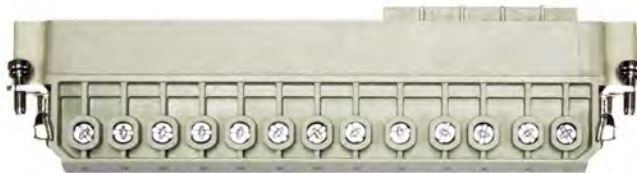

Wiring terminal screws

TABLE 13

Number of Contacts	26 + Gnd
Rated Current	10 Amps
Rated Voltage	250 V AC/DC
Insulation	$\geq 10^{10}$ ohms
Material	Polycarbonate
Temp. Range	- 40 to + 125 degree C
Mating cycles	> 500
Terminals	Screw type, copper alloy, hard silver plated Torque; 0.8N.m
Contact Resistance	≤ 5 micro-ohms
Wire size	10 to 16 gauge; stripping length 10 mm

Interlocks

Interlocks are at the very heart of the Citadel's ruggedness and safety practices.

Interlocks are designed to work SMOOTHLY and in layers.

The layering of one interlock on top of another is designed to increase the level of safety for operating personnel.

Every interlock is designed to "JUST WORK".

If ANYTHING does not work or does not appear to work SMOOTHLY

STOP!!!
DO NOT FORCE ANY ACTIVITY ON A CITADEL

Locate an experienced colleague or contact the factory ONLY.

NEVER FORCE ANYTHING !

The following section will describe the intent and operation of the various Citadel Interlocks. The order of this explanation will, for the most part, attempt to follow a breaker from being out on the floor through full insertion and operation. Stand-alone interlocks may be discussed at any time during this operational flow.

Padlocks

The Citadel switchgear cell has two hasps on the front door to allow for padlocking and LOTO locking with a customer provide multi-lock hasp device.

- One padlock hasp (optionally activated) is on the door handle.
- One padlock hasp (optionally activated) is on the door's racking port opening.
- Front Door Interlock

Some Customers have operating procedures that insist a breaker be turned off AND racked out – prior to the switchgear's front door being allowed to be opened.

The Citadel front door has an interlock supplied as standard – BUT DE-ACTIVATED. This interlock is mounted on the inside of the upper right side of the front door looking from the outside of a closed door. On the inside of the switchgear door is a bracket hanging vertically that when mounted horizontally with the two mounting screws provided will allow the racking indication arm to insert when the breaker is racked in and prevent the switchgear door from being opened when the breaker is racked in. As stated, this bracket is provided with only one mounting screw inserted and is hanging vertically. It is Non-operational in this vertical position.

B R E A K E R O P E R A T I O N

If Customer's wish to have an interlock that prevents the switchgear door from opening if the breaker is racked in, they will need to loosen the two mounting screws, rotate the bracket horizontally and then insert and tighten the two mounting screws.

If the interlock is ACTIVATED - THEREFORE; Note the following:

1. If this interlock is active and the breaker is racked-in with the door open – you will not be able to close and latch the door thereafter. The breaker position indication arm that would engage the interlock bracket will now be banging into that same bracket when you try to close the door.

You will have to rack the breaker out, close the door and re-rack the breaker into the connect position through the lower racking port hole in the switchgear front door.

2. If the breaker is racked in and someone attempts to open the door – IT WILL NOT OPEN! DO NOT FORCE IT! You will only bend the door.

Trip the breaker open and rack the breaker to the DISCONNECT position via the racking port on the switchgear front door. Then the door will easily open.

Customers who wish to open and close the switchgear door regardless of the breakers racked-in position should leave this interlock in the De-activated position or remove it entirely. After removing the bracket - replace the mounting screws in the front door holes to seal those holes permanently.

Discharge of the Closing Spring

It is a requirement of Standards for medium voltage draw-out switchgear that the closing spring of a circuit breaker is DIS-CHARGED as it is withdrawn from its cubicle. The Citadel breaker will discharge the energy of the close spring in both directions of insertion into a cell and extraction from a cell. The close-spring discharge function is basically a close / trip operation. As the breaker rolls over the switchgear's front door saddle area – there are fabricated “bumps” on the floor that will lift the breaker's close and trip levers thereby discharging the energy that would be stored in a close-spring that might have been charged.

Note – the discharging of Citadel close-spring is the same as closing the breaker and therefore there will be a loud BANG when the operation occurs.

This is normal.

The entire sequence can be avoided if the Operator mechanically presses the manual trip then close button and then presses the manual trip button again prior to rolling the breaker into or out of the cubicle .

Disconnect position lock (Patent pending)

A large ergonomically comfortable bar type handle for moving the Citadel in and out of the cell and around on the floor is provided.

Directly below the bar type handle is a spring Interlock bar. As the breaker enters the Disconnect position, this Interlock bar will ride up and fall behind inclined brackets on the upper left and right hand sides of the Citadel switchgear cubicle. This joining of the Interlock bar with the rear edge of the Disconnect brackets will occur both when the breaker is being rolled into the cell / or racked out of Connect to the Disconnect position. The interlock bar needs to be manually lifted to disengage it from the rear edge of Disconnect brackets. No specific efforts are needed regarding this interlock when racking the Citadel into the cell's Connect position from the Disconnect position.

Block the Racking Port

Citadel breakers are racked into and out of their respective cells via a racking tool inserted into the breaker's racking port. The racking port is located at the center of the lower portion of the breaker. The racking tool can be inserted into the racking port directly on the front of the breaker with the switchgear door open or through the door's racking port opening with the switchgear door closed. The Citadel breaker has a shutter mechanism that lowers a metal plate and blocks the breaker's racking port if the Citadel Breaker is closed.

FIGURE 83A

FIGURE 83B



YOU ARE NOT ALLOWED TO RACK A CLOSED BREAKER !

The Citadel works to protect Operators from attempting to do this by sealing off any access to the racking port opening.

If an attempt to insert the racking tool is made (either directly through the front of the breaker or through the switchgear door) and the tool does not insert into the breaker and feels clearly like it is being impeded – **STOP !!**

Verify the breaker's condition and trip the breaker open before attempting to insert the racking tool again.

The Citadel Breaker can ONLY be racked if the breaker is in the Open condition. The Citadel will remain in that Open condition for the full time the breaker is traveling (racking) between the Disconnect and the Connect positions, or as long as the racking tool is inserted. The Citadel will only become operable to close after it is fully in the Connect position or fully in the Disconnected position AND the racking tool is removed from the racking port.

(Citadels can operate on the floor when removed from the cubicle).

Citadels are cognizant that America's most popular GE Magneblast Breakers used a "Block the Close" racking procedure.

**GE Magneblast Block the Close - Dis-Engaged
(mechanical mechanism block & cut-off permissive switch disengaged)**

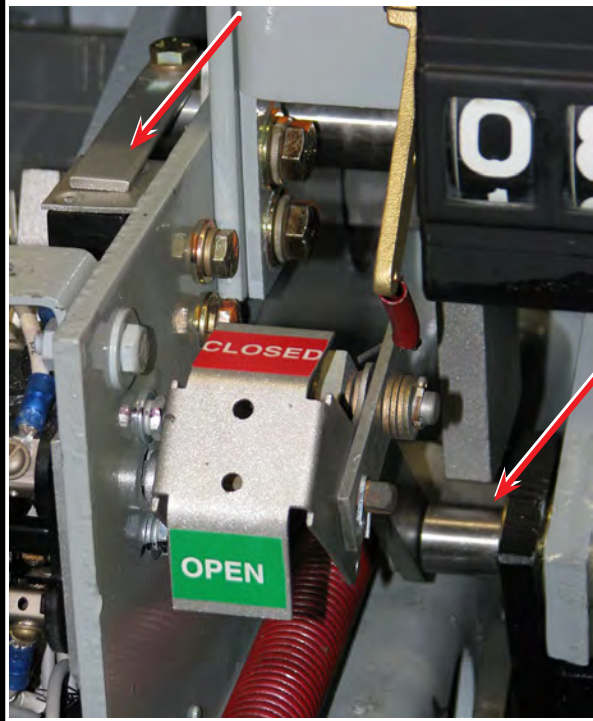

FIGURE 84

**GE Magneblast Block the Close - Engaged
(mechanical mechanism block & cut-off permissive switch engaged)**

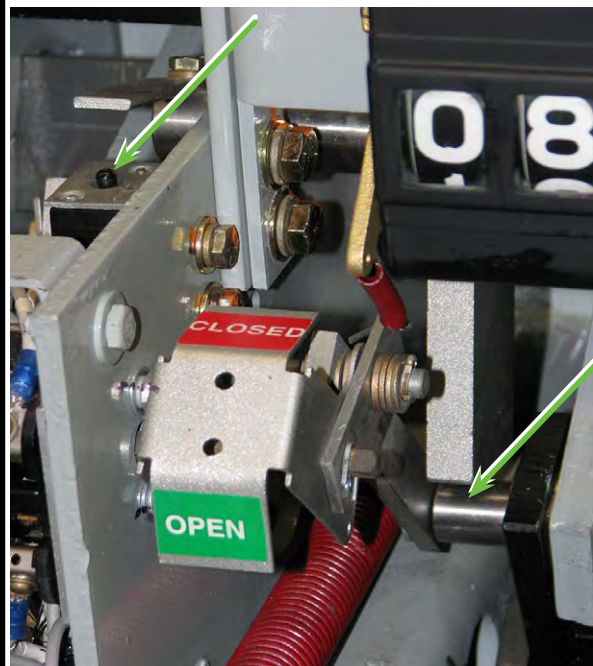

FIGURE 85

Block the Close

An additional layer of Safety for operating personnel is added to draw-out Citadel breakers by an interlock known as “Block the Close”. Whenever the racking tool is inserted into the Citadel racking port – the block the close lever is lifted and the interlock is ENGAGED. No Closing of the breaker can be accomplished either manually or electrically while the block the close feature is activated. When “Block the Close” is active – two micro switches disable the charging motor and close coil circuits.

Inserting the Racking Tool

The racking tool will insert easily into the breaker racking port with the switchgear door open or closed **WHEN THE BREAKER IS TRIPPED OPEN ONLY !**

(see - Block the Racking Port). As you slide the racking tool into the port / rotate the tool by hand in ½ rotation increments so that the detents in the front of the racking tool engage their counterparts on the breaker.

As the racking tool inserts, the “Block the Close” interlock will automatically engage. When “Block the Close” is active – two micro switches disable the charging motor and close coil circuits.

The Citadel breaker cannot be closed manually or electrically while the racking tool is fully inserted into the Citadel.

Once fully inserted – turn the racking tool, in ½ to 1 turn increments, and assure yourself the tool is well seated.

Turning the racking tool clockwise – either manually or with the OPTIONAL remote racking device will rack the breaker into the Connected position.

Turning the racking tool counterclockwise – either manually or with the OPTIONAL remote racking device will rack the breaker into the Disconnected position.

Make sure you have fully racked the breaker in or out before removing the racking tool.

The Citadel will NOT operate if it is NOT in the fully Connected or fully Disconnected positions.

The “Block the Close” interlock will stay lifted and engaged in All positions other than fully Connected or fully Disconnected.

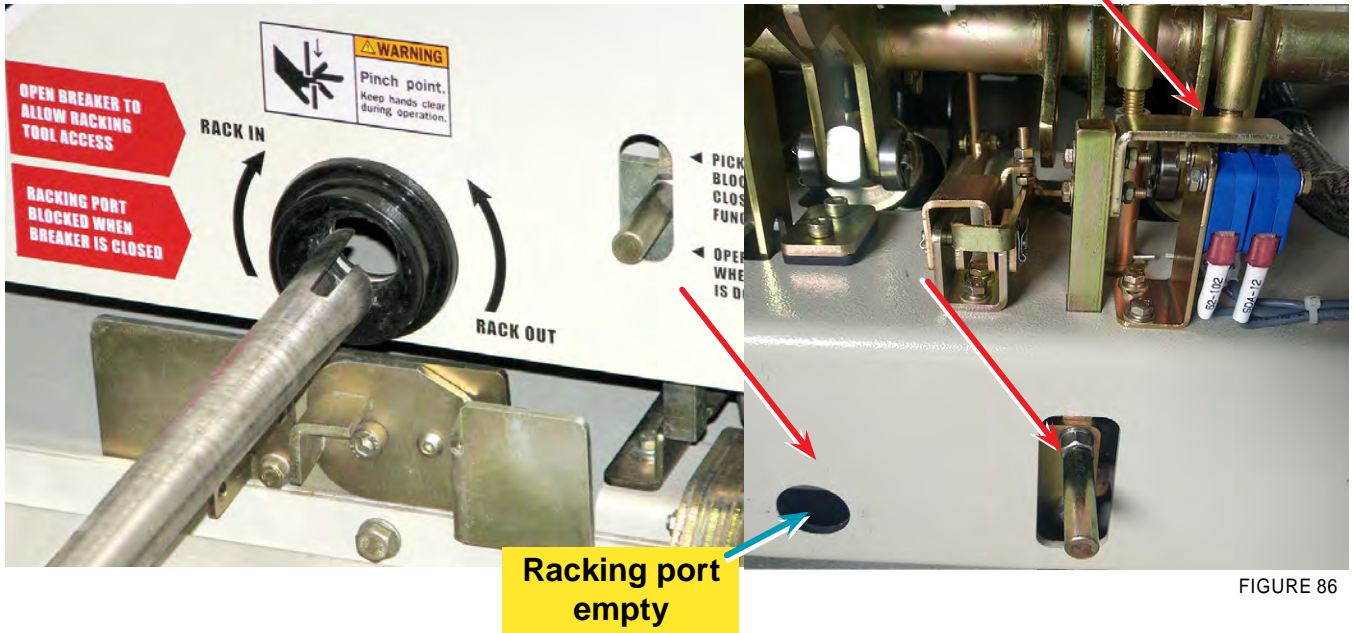

FIGURE 86

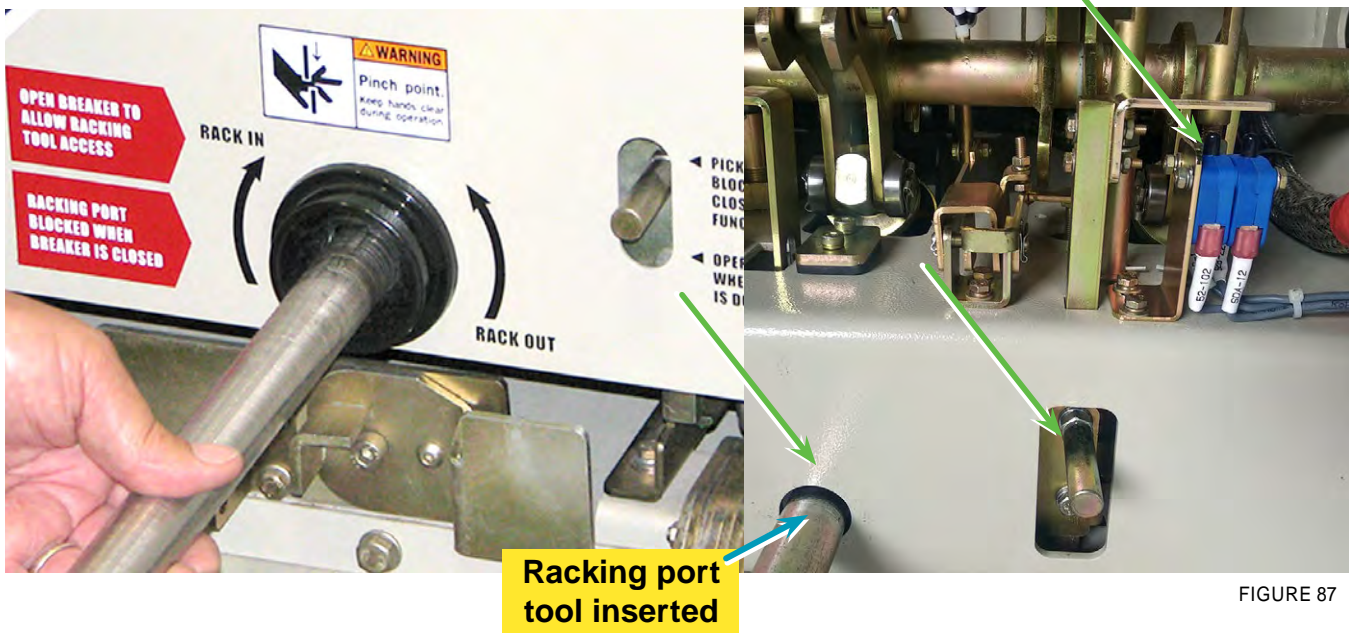
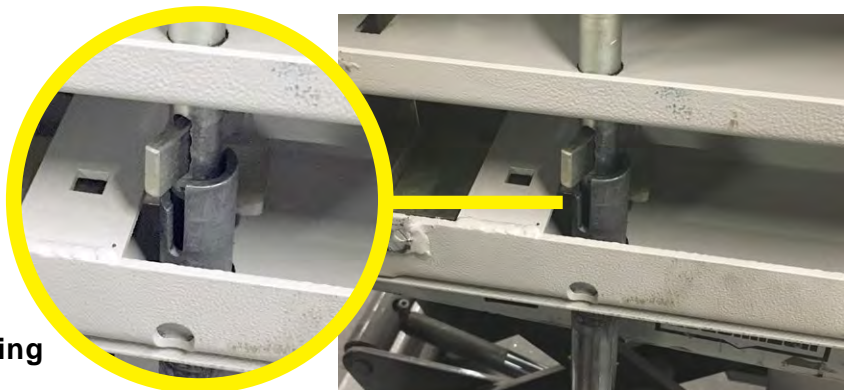

FIGURE 87



The insertion of racking tool engages breaker racking screw in this manner



FIGURE 88

Close door racking standard



FIGURE 89

CRS - (Citadel Racking System) - Son of DH-P (Patent pending)

The Westinghouse DH-P circuit breaker produced at the fabled East Pittsburgh switchgear works had a unique and ingenious racking device that allowed the breaker to fully rack in or fully rack out and then the racking screw would simply Spin Free. This provided positive feedback to the Operator that the breaker was in its final and correct position and insured the switchgear could not be damaged by over racking in either direction.

The Citadel breaker and switchgear improves on this exceptional safety concept by improving the ruggedness and simplicity of the parts required for this feature to operate.

Once a Citadel breaker is fully racked in or fully racked out – the racking screw will simply spin free.

(Kirk type) Key Lock (Optional)

On the very front / center floor of the Citadel switchgear can be optionally mounted a bracket that operates with a key type lock (or a pad lock).

Manually rotating the bracket in the UP position allows operating personnel to turn the key-lock and extend a lock bolt that will hold the bracket up or insert a hasp lock that will provide the same “lock in place” functionality. In the UP position the bracket negates the ability to insert the racking tool, thereby locking the breaker in place.

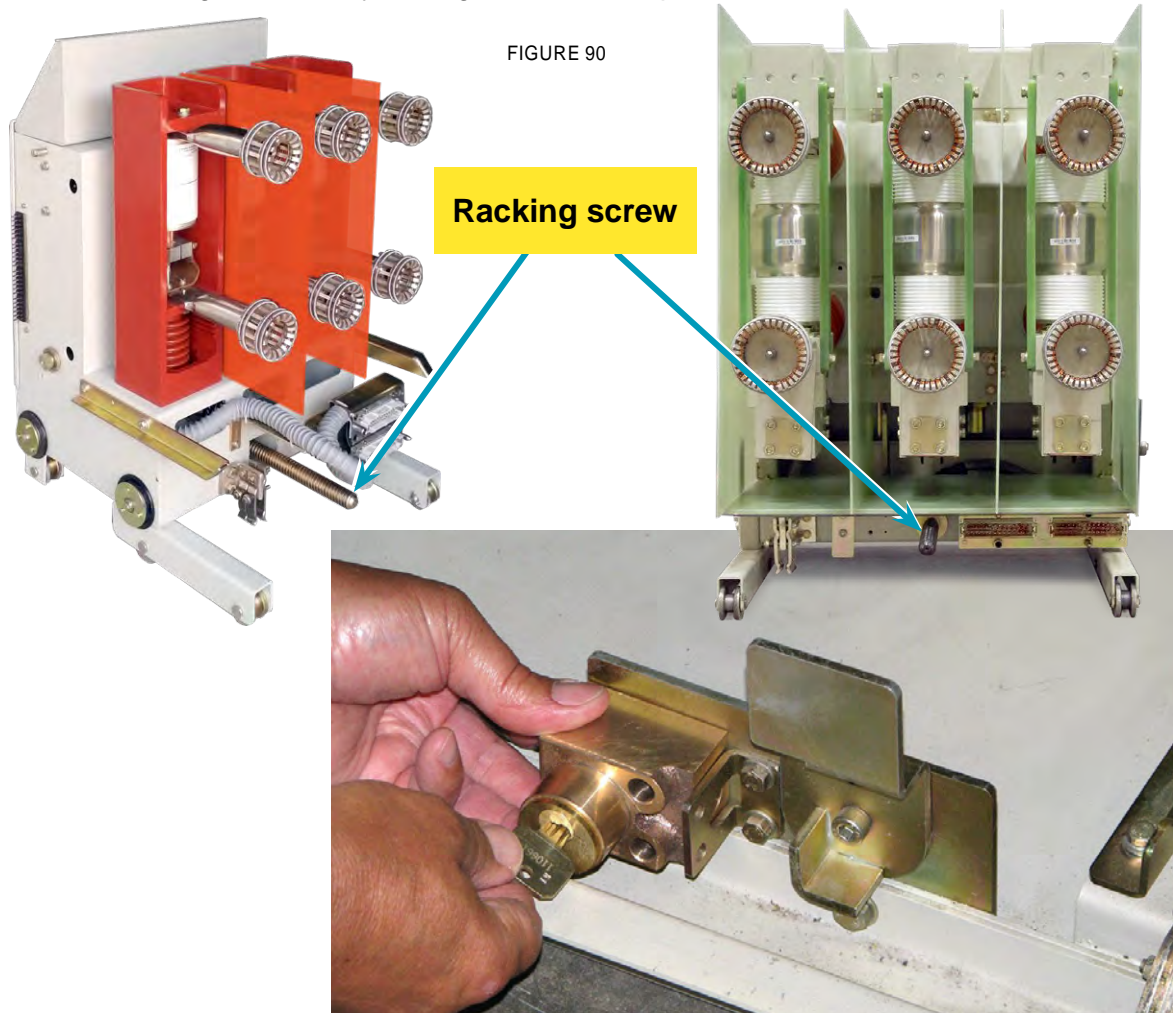

FIGURE 90

Breaker Rating Interference Key

All Citadel breakers will be provided with a special bracket that allows only the proper rated breaker to be inserted into an associated properly rated switchgear cubicle. On the floor of the Citadel Cubicle is mounted a universal bracket with comb teeth along its top edge. The breaker has mounted on the lower rear portion of the draw out carriage a mating key that allows the two bracket to slide past each other. Only when the proper teeth sequences line up will the breaker be able to continue the insertion into the cell. If you are trying to insert a breaker into a cell and it bangs up against something – **STOP !!**

Discontinue the insertion process and exam the breaker nameplate. Verify that the breaker in question is specifically rate to go into that specific cubicle by both rating and function. Breakers that have certain functions such as Generator Breakers or Capacitor Switching breakers or Ground & Test devices may have inference brackets to limit the cubicles they are allowed to be inserted into. If so, such breakers (devices) will be provided with an Interference Key that will impede the ability of an operator to put that specific breaker (device) into any general cell even if the ratings are proper.

If everything continues to look OK but the breaker does not easily enter the cubicle –

CALL FOR FACTORY AUTHORIZED SERVICE ONLY.
NEVER attempt to force a breaker into a switchgear cubicle.

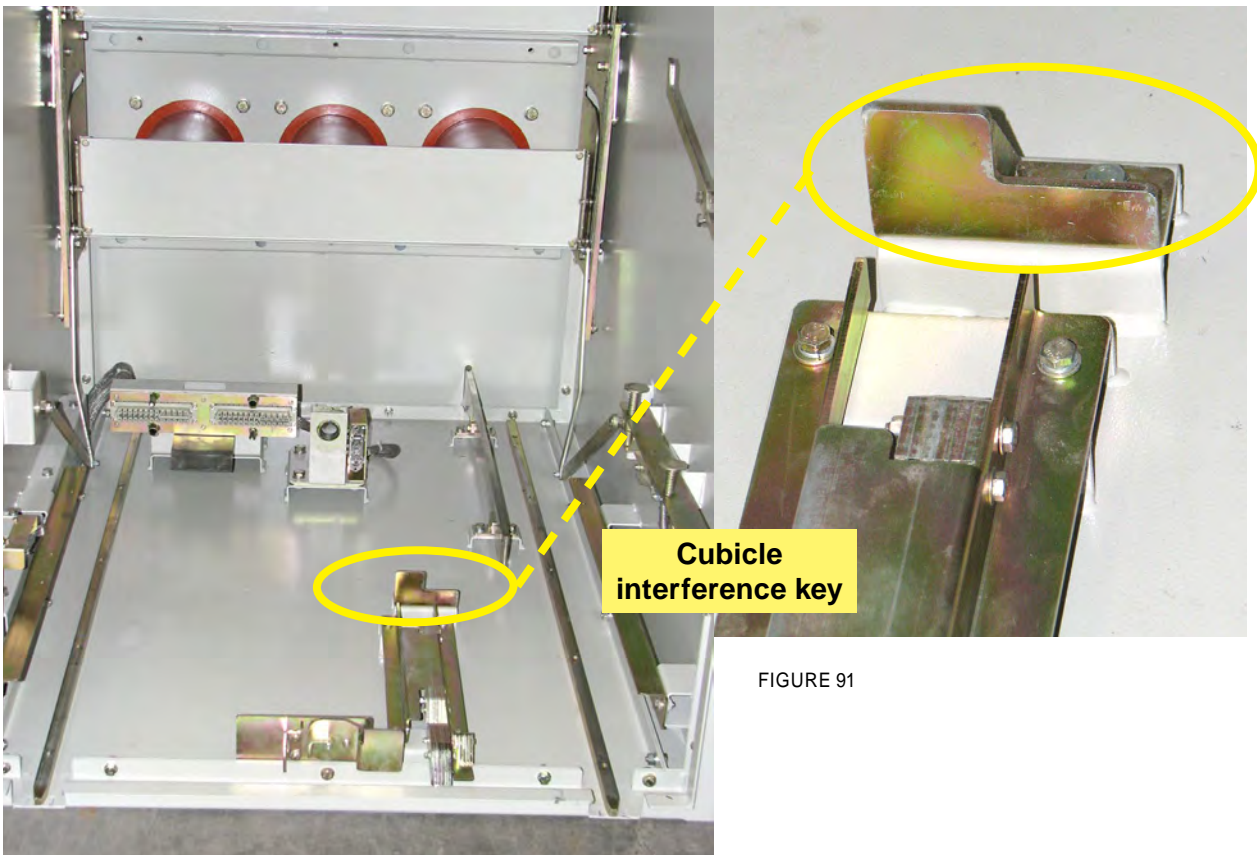

FIGURE 91

Introduction

The Citadel circuit-breaker's operator mechanism is employed for fixed mounted and draw-out switchgear applications conforming to the applicable requirements of ANSI/IEEE standards, including C37.20.2, C37.04, C37.06, C37.09 and C 37.013.

The Citadel product line is generally applied to distribution circuit breaker applications. See manuals on Citadel - 63 - 5000 for more Generator Breaker specifics.

Mode of operation

The operating mechanism is of the stored-energy "trip-free" type.

The mechanical energy for carrying out an "open-close-open" sequence for auto-reclosing duty is stored in the closing and tripping springs.

The charging of the closing spring is not automatically followed by the contacts changing position. A determined closing signal must be provided for a close operation to occur and the tripping function takes precedence over the closing function. See ANSI / IEEE 37.04 section 6.9 for details

When the stored-energy mechanism has been charged, the mechanism is ready to perform a closing operation.

The Citadel can now perform any of the following operating sequences;

- Open;
- Close;
- Open / Close;
- Close / Open;
- Up to an "Open-Close-Open" sequence for auto-reclosing duty.

When a close command is given to a charged Citadel element, the energy in the closing spring is released and forces a rotation of the breaker mechanism's main armature shaft. That main shaft rotation will laterally push three (3) "push rod" assemblies that will ultimately drive the movable stem of the vacuum bottles' moving contact assembly into a closed (mated) position with the stationary contact assembly of the vacuum interrupter.

During the closing operation, the opening spring takes some of the closing energy and is itself charged.

A latching pawl falls into position and holds the opening spring assembly in a ready position to quickly operate when called upon.

When an opening command is given, the holding pawl unlatches and the energy stored in the opening spring and pushrod assembly contact pressure springs is released.

BREAKER OPERATION



THIS QR CODE WILL LINK TO A VIDEO OF THE CITADEL MECHANISM IN OPERATION

OPEN

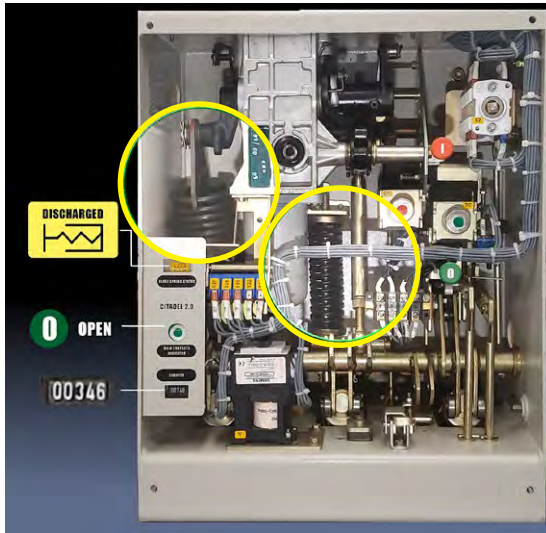

DISCHARGED & OPEN - FIGURE 92A

CLOSE

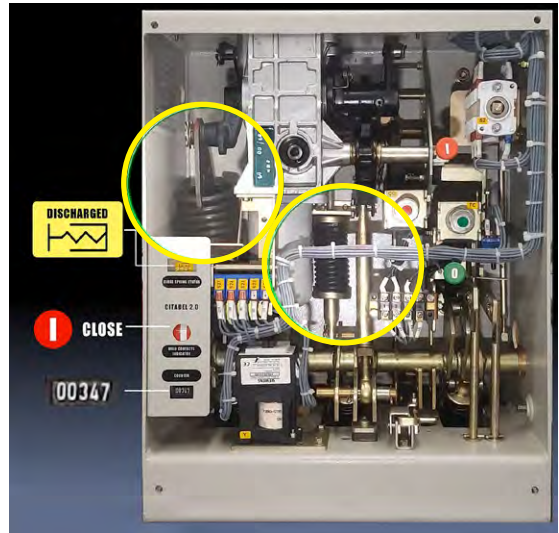

DISCHARGED & CLOSE- FIGURE 92B

OPEN

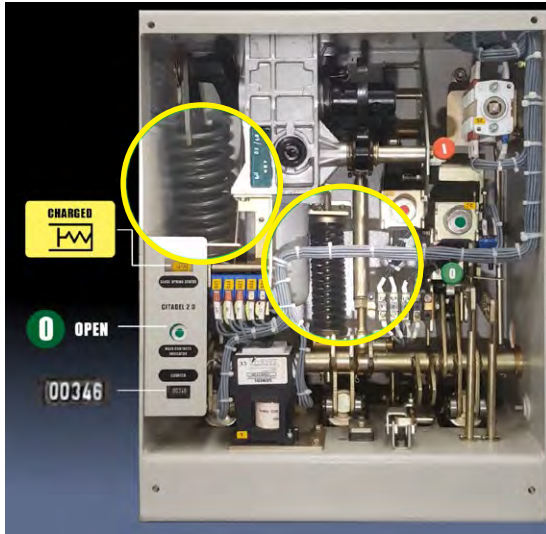

CHARGED & OPEN- FIGURE 92C

CLOSE

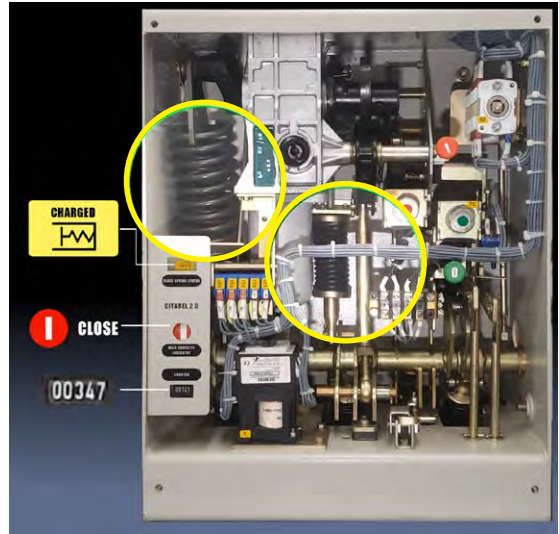

CHARGED & CLOSE- FIGURE 92D

CONTACT PRESSURE SPRING

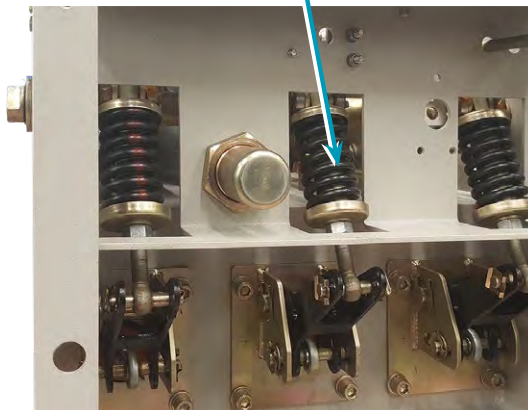

FIGURE 93A: POSITION OF PUSH RODS AND PRESSURE SPRINGS WHEN BREAKER OPEN

ANGLED CAM LEVER

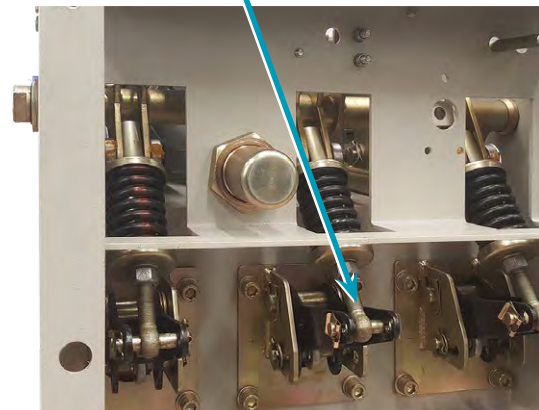

FIGURE 93B: POSITION OF PUSH RODS AND PRESSURE SPRINGS WHEN BREAKER CLOSE

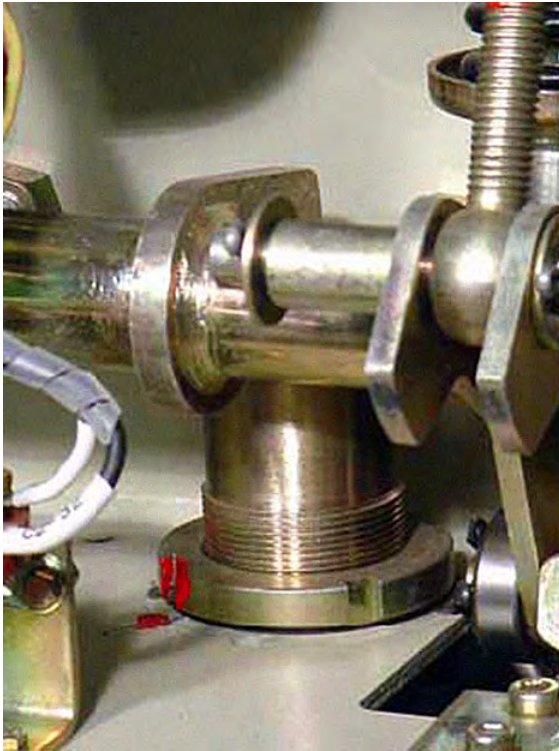

FIGURE 94

Hydraulic Shock Absorber

The Citadel mechanism employs a shock absorbing devices.

The shock absorber should be visually inspected during regular maintenance intervals to verify that there is no evidence of leakage. If shock absorber is leaking, it requires replacement.

Barring any leakage, the shock absorber requires no maintenance or adjustments during the life of the breaker.

Trip-free operation of draw-out breakers (refer to Figures 95)

All draw-out Citadel circuit breakers are of a trip free design.

Breakers that are not in the proper position within the cell (i.e. they are not in Connect or Disconnect positions) or have certain dedicated trip free interlocks engaged; will immediately trip open upon being given an unblocked signal to close.

The close signal may come from the breaker's front panel mechanical push button, an electrical actuation of the close coil, or draw-out cell floor rails lifting the close linkage.

Fixed mounted Citadel elements that are used to vacuum convert older air breakers will have the same trip-free operation as actuated by the original breaker's linkages.

Fixed mounted breakers can also optionally have a key lock (Kirk key or similar) to provide trip-free interlocking function.

Customers should consider "Block the Close" interlocking for additional safety. Contact the factory to learn more about the Citadel's "Block the Close" capability for fixed mounted elements used for roll-in replacement breakers.

Citadel Draw-Out switchgear automatically incorporates the block the close interlocking and protective function for improved operator safety.

FIGURE 95

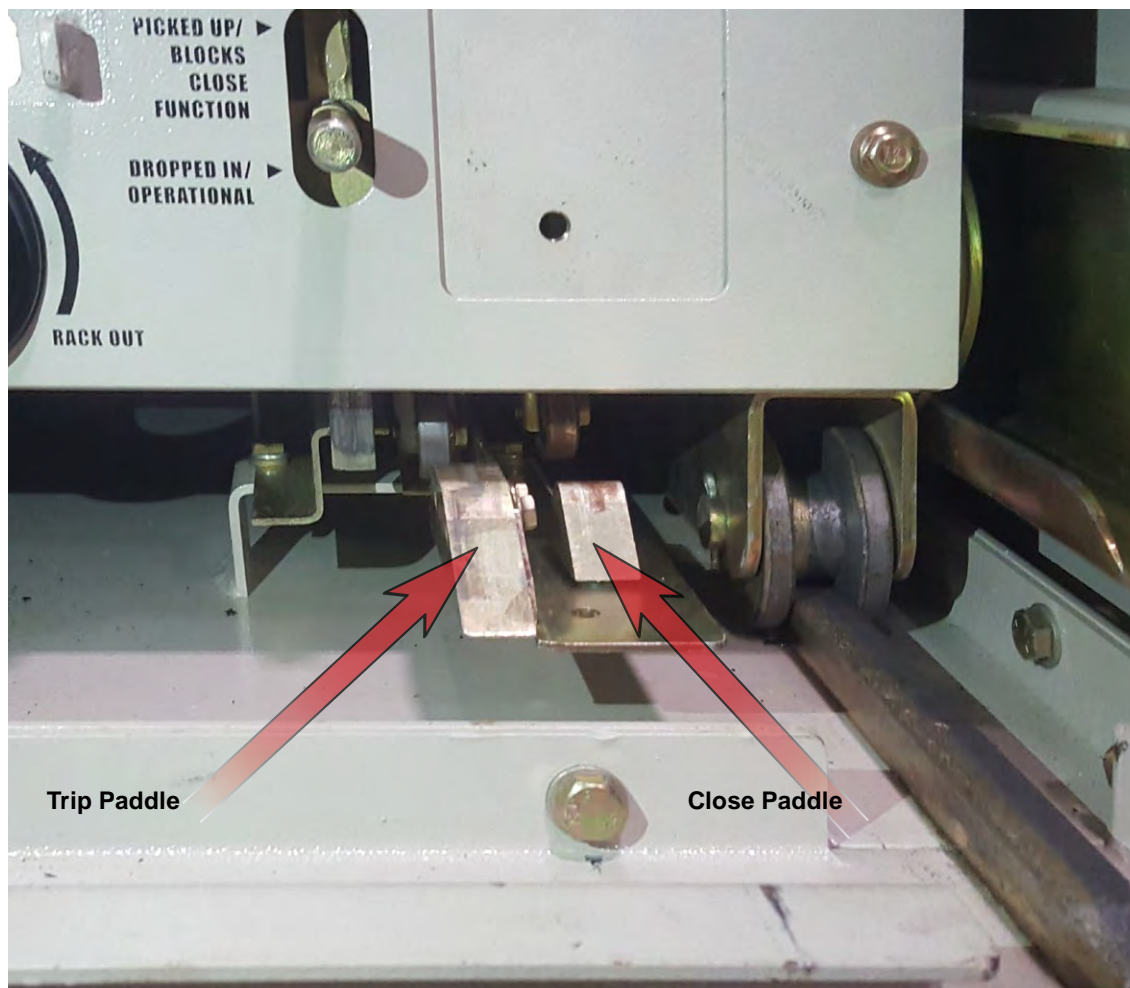

CLOSE & TRIP TAKE-OFF EXTENSION RODS

The Fixed Mounted Citadel was developed to maximize ease of conversion of older breakers.

In order to maintain (or upgrade) the original breaker so that it incorporates “trip free” racking and “close-spring discharge”; the Citadel is provided with assemblies that access the trip and close linkages. Both are easily accessed via extension rods.

The extension rods are located at a convenient point, extending through the lower right hand bottom of the breaker’s mechanism enclosure. Each extension rod comes with threaded inner diameters to accept an M6 bolt.

NBS takes no responsibility nor warrants the interface connections provided by any breaker conversion company between the original breaker’s “trip free”, & “spring discharge” systems, and those of the Citadel.

DANGER



When the Citadel mechanism is held mechanically tripped, the main contacts of the vacuum interrupters briefly touch (kiss) as the breaker goes through a close/trip cycle.

DANGER



It is imperative that the Citadel element is not allowed to have its contacts briefly touch (kiss) while it is being racked off the main voltage primary connections.

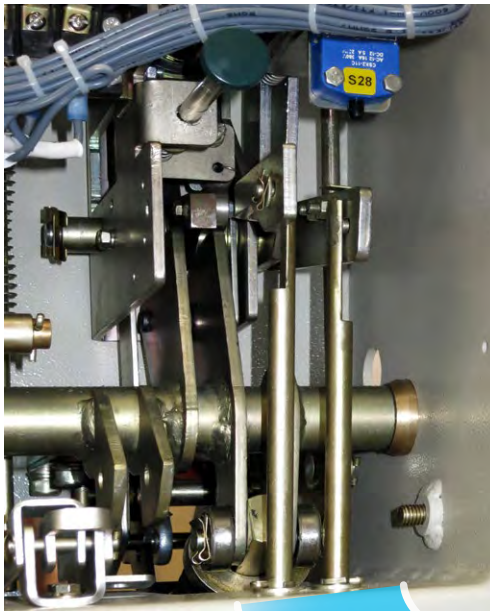
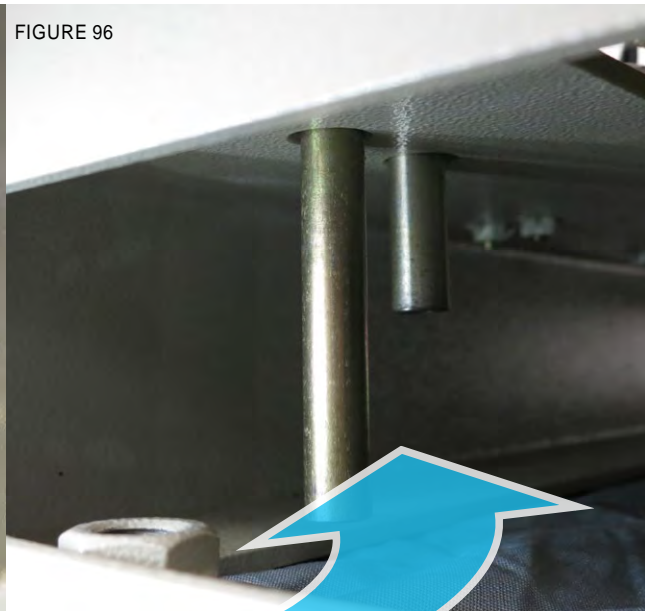

FIGURE 96



Close & Trip Extension Rods
from underneath

POSITIVE “BLOCK THE CLOSE” INTERLOCK

The Citadel element incorporates a specially designed mechanical “**Block the Close**” Interlock. The block the close engagement lever is located on the bottom of the mechanism housing and slightly to the right of center.

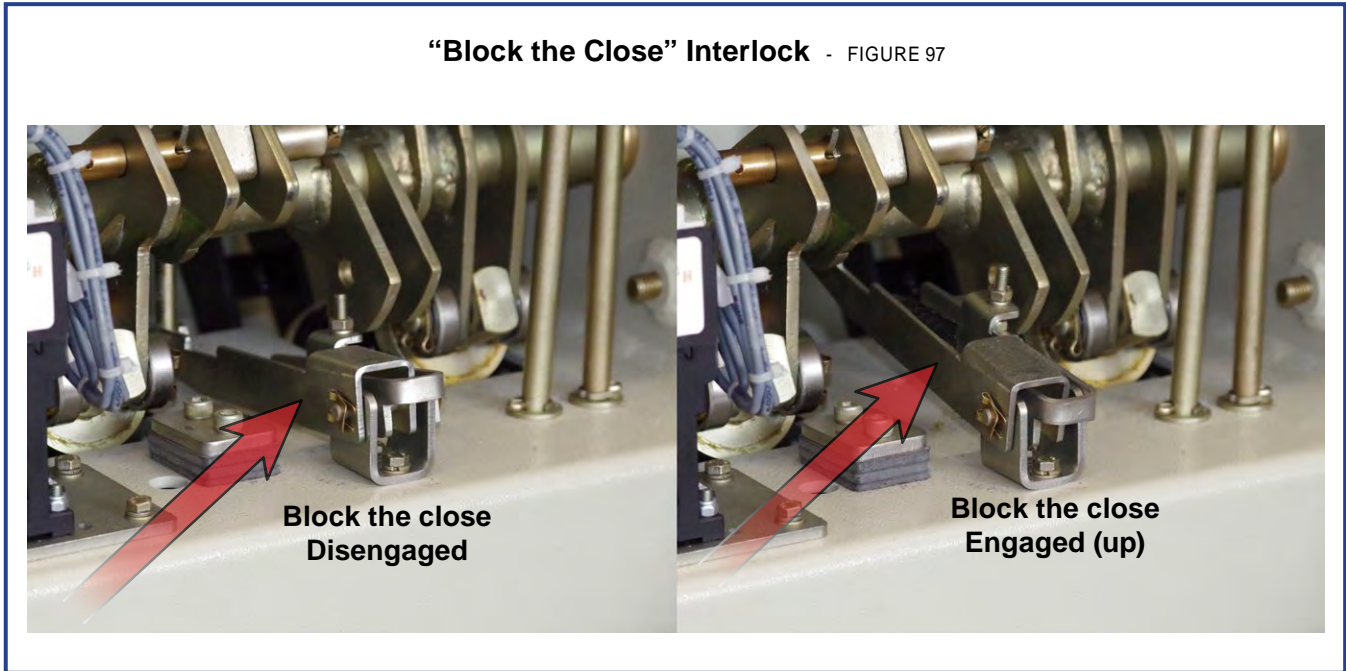

When the breaker is in the open position and the “Block the Close” Interlock is raised (engaged), this interlock will mechanically prevent the breaker from closing whether the close signal is a manual push of the close button, an electrically initiated signal or an inadvertent shock to the Citadel element.

DANGER 	Interlocks are designed and incorporated to add to the safe operation of the Citadel. They are not a replacement for proper operating practices and safe, well trained personnel.
--	--

The “Block the Close” interlock is an option designed into the fixed mounted Citadel element. It is not necessarily employed during the conversion process. Customers should learn about this optional feature and its possible inclusion in any final conversion design.

NBS takes no responsibility nor warrants the interface connections provided by any breaker conversion company between the original breaker’s “trip free”, & “spring discharge” systems, and those of the Citadel.

MASTA - MAIN ARMATURE SHAFT TAKE-OFF ASSEMBLY

The Fixed Mounted Citadel was developed to provide convenience for conversion of older breakers as well as easy connections of mechanical linkages for fixed mounted applications.

Older breakers often require the roll-in replacement conversion to interface with an original M.O.C. (Mechanism Operated Cell) switch operator.

MASTA: Main Armature Shaft Take-off Assembly

MASTA extensions

The Citadel provides three locations to make these connections:

- Two machined extensions of the Main Armature Shaft with a threaded center hole are found on the far left and right sides of the breakers Main Armature Shaft.
- One coupling dowel is located on the center of the Main Armature Shaft at the point it is coupled with the Main Drive Shaft.

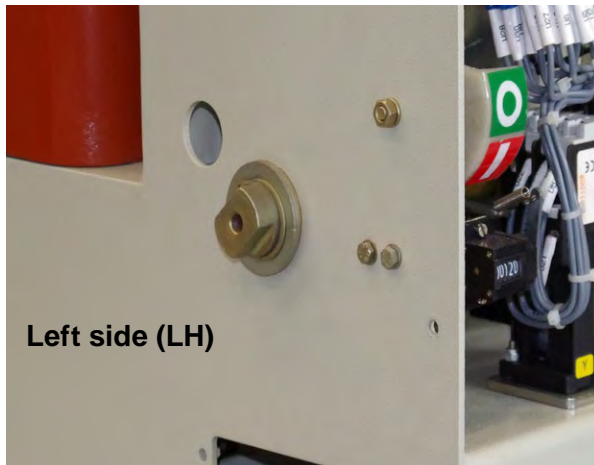

FIGURE 98A

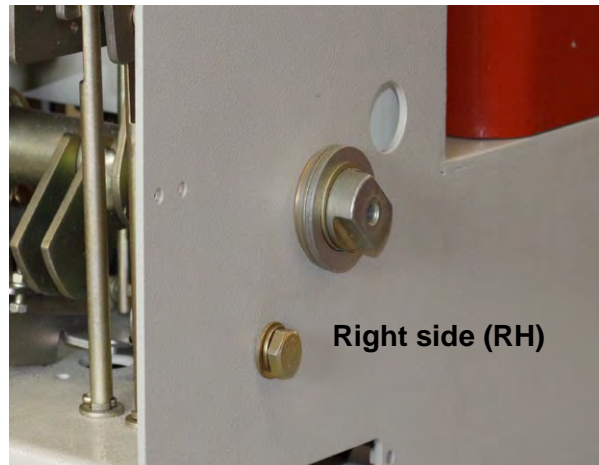

FIGURE 98B

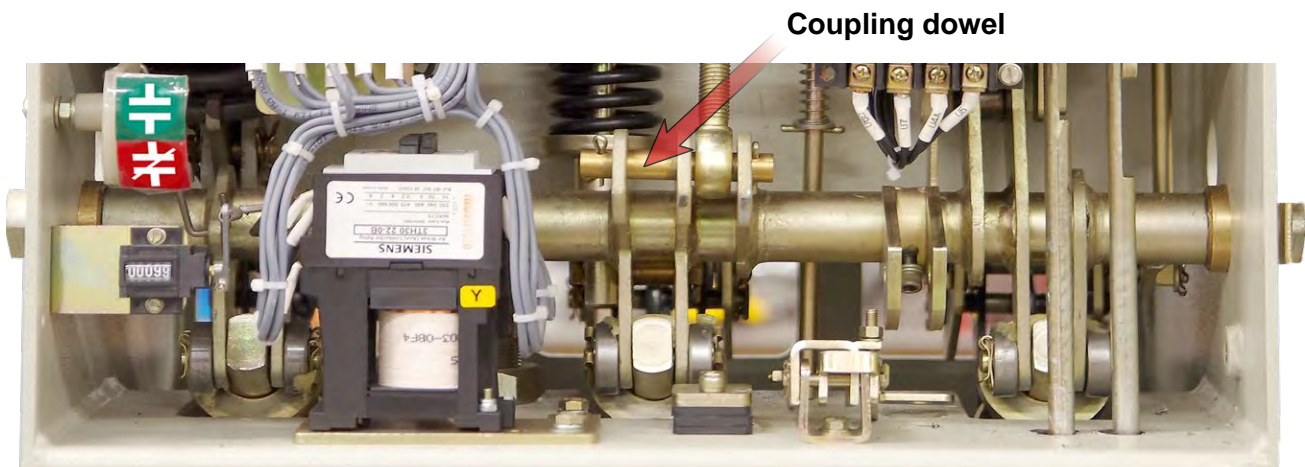
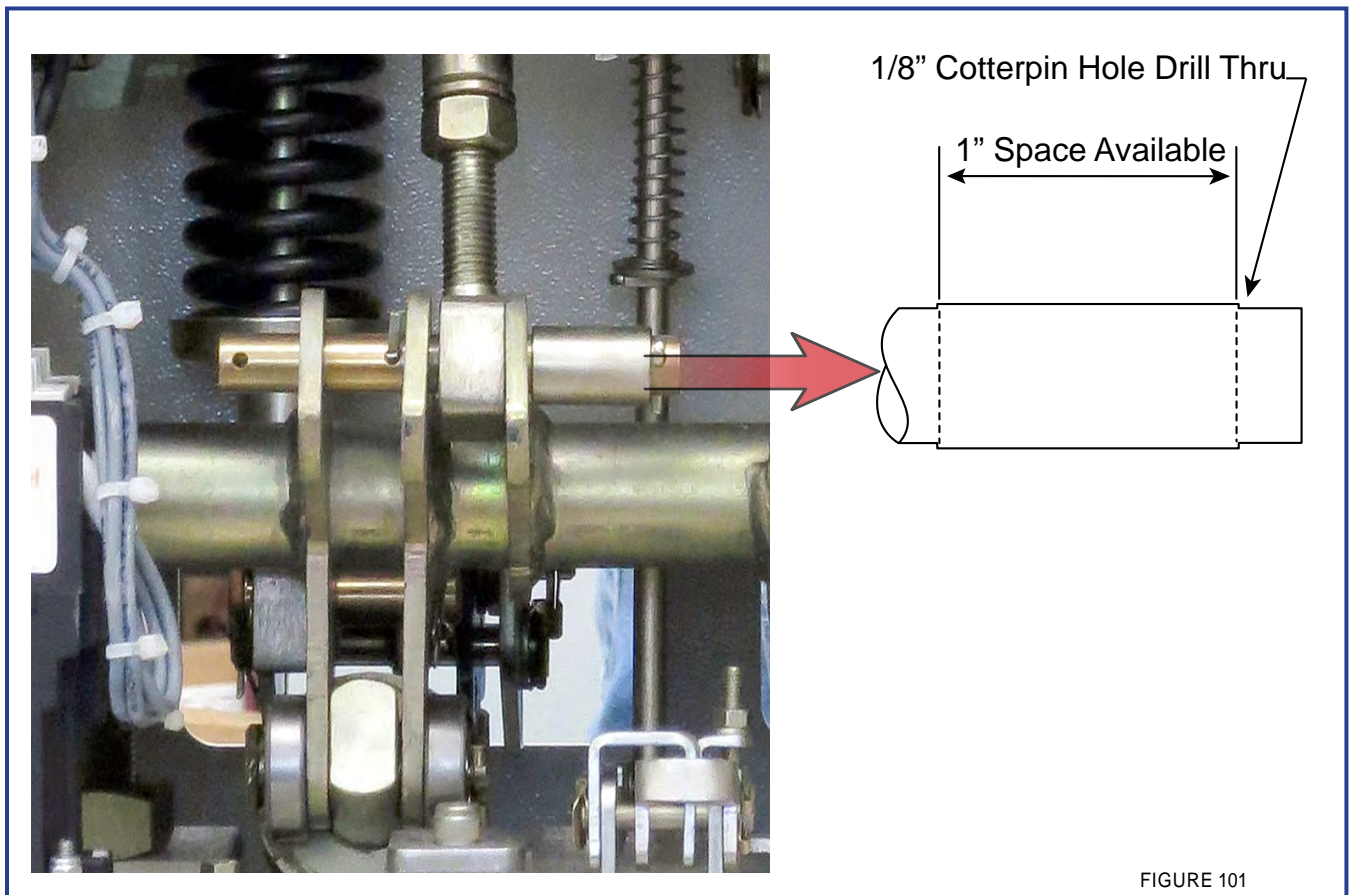
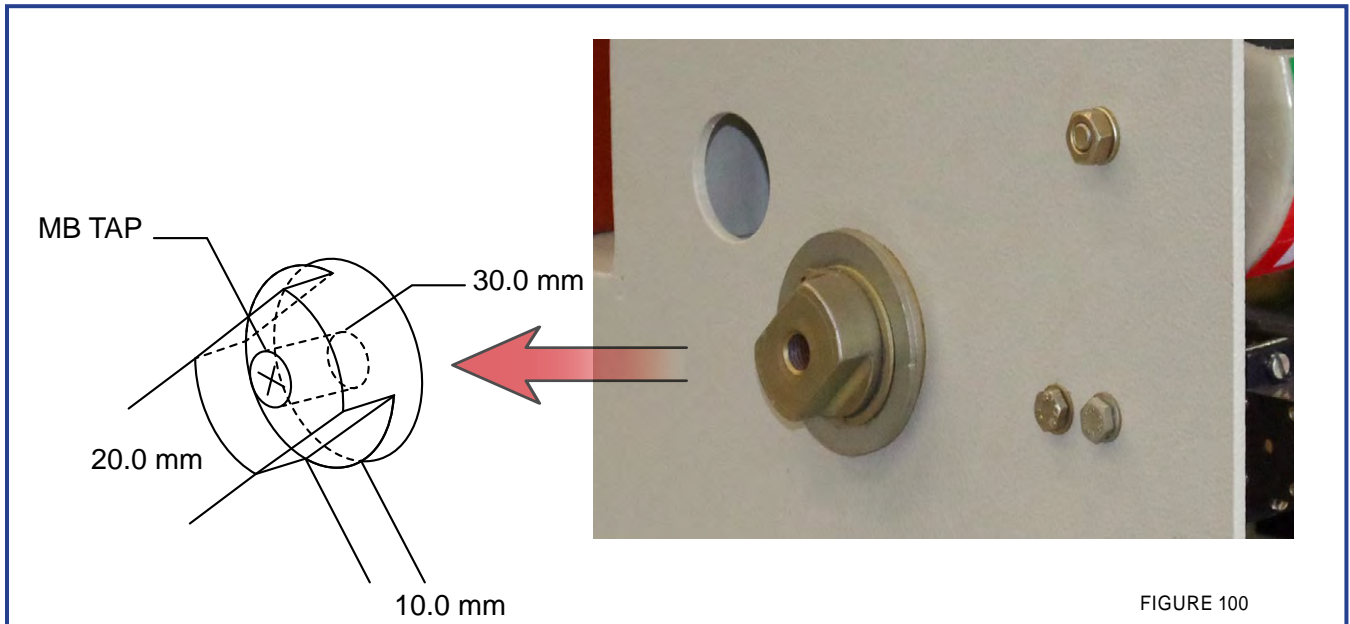

FIGURE 99



NAME PLATES

Draw-out Breaker Nameplate

CITADEL

SERIAL NO. _____ DATE MFG _____ JOB NO. _____

BREAKER TYPE CITADEL - _____ RATED CURRENT _____ A

RATED MAX VOLTS _____ IMPULSE WITHSTAND _____

RATED SHORT CIRCUIT AMPS _____ kA INT TIME _____ CYCLES

RATED VOLTAGE RANGE FACTOR 1.0 FREQUENCY 60 Hz

CLOSE+LATCH CAPABILITY _____ kA DC COMP _____ %

OPERATING DUTY CYCLE 0-0.3 SEC-CO-3 MIN CO

CLOSE COIL VOLTS _____ VDC RANGE _____ VDC AMPS _____

CHARGE MOTOR VOLTS _____ VDC RANGE _____ VDC AMPS _____

TRIP COIL 1 VOLTS _____ VDC RANGE _____ VDC AMPS _____

TRIP COIL 2 VOLTS _____ RANGE _____ AMPS _____

CAPACITANCE CURRENT SWITCH C2 RATED _____

VAC INTER. MODEL _____ S/N A _____ B _____ C _____

CONNECTION DIAGRAM _____ MODEL NO _____ WT _____ LBS.

NATIONAL BREAKER SERVICES MIDDLEBURY CT 06762
(800) 806-5552

FIGURE 102

Citadel Conversions Nameplate



National Breaker Services

(800) 806-5552

SERIAL# - _____

STYLE# - _____

MANUAL# - _____

DATE - _____ WEIGHT - _____

AIR CIRCUIT BREAKER RATINGS		CONVERTED BREAKER RATINGS	
TYPE - _____	AMPS - _____	TYPE - _____	AMPS - _____
RATED KV - _____	RATED MVA - _____	RATED KV - _____	RATED KA - _____
MAX KV - _____	INT AMPS - _____	MAX KV - _____	INT AMPS - _____
BIL KV - _____	MAX AMPS - _____	BIL KV - _____	MAX AMPS - _____
HERTZ - _____	CLOSE AMPS - _____	HERTZ - _____	CLOSE AMPS - _____
INT TIME - _____	K FACTOR - _____	INT TIME - _____	K FACTOR - _____
CLOSE VOLTS RANGE - _____		CLOSE VOLTS RANGE/AMP - _____	
CHARGE VOLTS RANGE - _____		CHARGE VOLTS RANGE/AMP - _____	
TRIP VOLTS RANGE - _____		TRIP VOLTS RANGE/AMP - _____	

FIGURE 103

TABLE 14

Nameplate Content - Explained	
Type	Designates circuit breaker model number and broadly identifies application in terms of maximum voltage and interruption capabilities
Amps amperes	Rated continuous current is the designated limit of current in RMS at rated frequency, which the breaker may be expected to carry without exceeding temperature limitations.
Rated Max Volts kV	The highest RMS voltage above nominal system voltage for, which the circuit breaker is designed, and is the upper limit for operation.
Volt Range Factor(k)	The ratio of rated maximum voltage to the lower limit of the range of operating voltage in which the required symmetrical and asymmetrical interrupting capabilities vary in inverse proportion to operating voltage.
BIL kV	The rated full wave impulse withstand voltage. The crest value of a standard 1.2 x 50 impulse voltage wave which a new circuit breaker must be capable of withstanding without flashover or puncture during design tests.
Rated Short kA	The symmetrical component of short-circuit current in RMS Circuit amperes, which the breaker may be expected to interrupt
Close & Latch kA	The maximum making current into which the circuit breaker may be expected to close and latch.
Inter Time Cycle	The maximum permissible interval between energizing the trip Circuit at rated control voltage and the interruption of the main circuit in all poles.
Hz	Rated frequency is the sinusoidal periodicity at which the circuit breaker is designed to operate.
Wiring Diagram	An elementary diagram providing detailed information regarding electrical function and wiring within the circuit breaker.
Motor (Spring Charging) Volt Range	Range of control voltages required to serve the motor which stores energy in the closing springs.
Amps Nominal (Motor)	Effective value of current required at nominal control voltage when applied to serve the motor, which stores energy in the closing springs.
Close(Solenoid) Volt Range	Required range of control voltage applied to the closing solenoid which will insure successful release of the closing spring and Citadel mechanism.
Amps Nominal (Close Coil)	The effective value of current required at nominal control voltage when applied to the close spring release solenoid.
Trip (Solenoid) Volt Range	Required range of control voltage applied to the tripping Volt (opening) solenoid, which will ensure a successful Range tripping (opening) solenoid.
Amps Nominal (Trip Coil)	The effective value of current required at nominal control voltage when applied to the trip spring release solenoid.
Manual Reference to the instruction manual applicable to the circuit breaker by publication number.	
LBS	Weight in pounds of the complete circuit breaker element.
Serial No	Specifically identifies an individual breaker and affords trace ability to test records and manufacturing dates.
Date Mfg.	The month and year within which the circuit breaker was manufactured.

M A I N T E N A N C E

This section covers Inspection, Preventive Maintenance, Maintenance and Good Operating Practices

The following is NOT in any way to be considered exhaustive.

WARNING



PERSONS not fully trained and practiced at the tasks before them **Should Not** attempt to operate, or make any attempts at maintenance. Employ factory trained persons only for all operating and maintenance functions and / or training of site personnel to perform certain portions of these tasks.

WARNING



VERY Important Note

CLEANLINESS is a major requirement for the longevity and proper operation of most medium voltage equipment – the Citadel is no exception.

Beyond any time frames noted in this instruction manual – it is not practical for the manufacturing supplier to be aware of the environmental conditions of each User's location.

It is the CUSTOMER'S sole responsibility to make practical, conservative estimates of the time frames needed to clean the Citadel and associated switchgear such that no fowling or degradation of insulation, or excessive wear of parts ensues.

WARNING



Citadel circuit breakers are mechanical devices.

They **MUST** be maintained properly.

Failure to properly maintain circuit breakers and switchgear can result in death, serious injury, property damage and premature product failure.

Improperly maintained equipment can prevent its successful functioning and the successful functioning of connected equipment.

The instructions contained herein should be carefully reviewed, understood and followed.

The maintenance tasks in Table 14 - page: 113 must be performed regularly

Introduction and maintenance intervals;

Regardless of the length of the maintenance and lubrication interval, Citadel breakers should be inspected, cleaned and electricly exercised every 18 to 36 months.

Each excercise should be documented and signed.

Periodic inspections and maintenance is essential for safe and reliable circuit breaker operation.

Under “usual service conditions,” Citadel circuit breaker lubrication is recommended at seven (7) year intervals. “Usual” and “Unusual” service conditions for medium-voltage circuit breakers and switchgear are defined in ANSI/IEEE C37.20.2, sections 4 and 8.1, ANSI/IEEE C37.04, section 4 and ANSI/IEEE C37.010, section 4.

Generally, “usual service conditions” are where the equipment is not exposed to excessive dust, acid fumes, damaging chemicals, salt air, rapid or frequent changes in temperature, vibration, high humidity and extreme temperatures.

The definition of “usual service conditions” is subject to a range of interpretations.

Therefore Customers are best served by adjusting the maintenance and lubrication intervals based on experience with the equipment in it’s own resident service environment.

A good rule is – “err on the side of conservatism and caution”.

Preventive maintenance programs are not intended to cover major repairs, reconditioning or remanufacturing. A good preventative maintenance program should reveal if such actions are warranted to prevent malfunctions during operation.

NBS highly recommends Users hire factory trained technicians to perform maintenance and preventative maintenance functions if on-site personnel are not thoroughly versed and trained on this equipment.

For the safety of maintenance personnel as well as others who might be exposed to hazards associated with maintenance activities, the safety related work practices of NFPA 70E (especially chapters 1 and 2) should always be followed when working on electrical equipment.

Maintenance personnel should be trained in the safety practices, procedures and requirements that pertain to their respective assignments.

This instruction manual should be reviewed and readily accessible for reference during maintenance of this equipment.

NFPA publication 70B, “Electrical equipment maintenance” may be used as a guide to establish such a program.

Recommended hand tools Metric hardware is used on these circuit breakers.

The following list of hand tools describes those normally used in disassembly and reassembly procedures:

- Open-end wrenches: 7, 8, 10, 13, 17, 19 and 24 mm
- Two open-end wrenches: 55 mm are used to exchange shock absorber
- Sockets: 7, 8, 10, 13 and 17 mm
- Socket: 36 mm (used for replacing post insulators)
- Deep sockets: 19 and 24 mm
- Hex keys: 5, 6, 8 and 10 mm
- Torque wrench: 0-150 Nm (0-100 ft-lbs)
- Screwdrivers: 0.032 x 1/4 in wide and 0.055 x 7/16 in wide
- Pliers
- Light hammer
- Dental mirror
- Flashlight
- Drift pins: 1/8, 3/16 and 1/4 in
- Retaining ring plier (external type, tip diameter 0.038 in).

*** The above list is subject to change without notice. Check the NBS website or call the factory for the most current information**

FASTENERS TIGHTNESS TORQUE CHECK LIST

RATING :

VCB SERIAL NO:

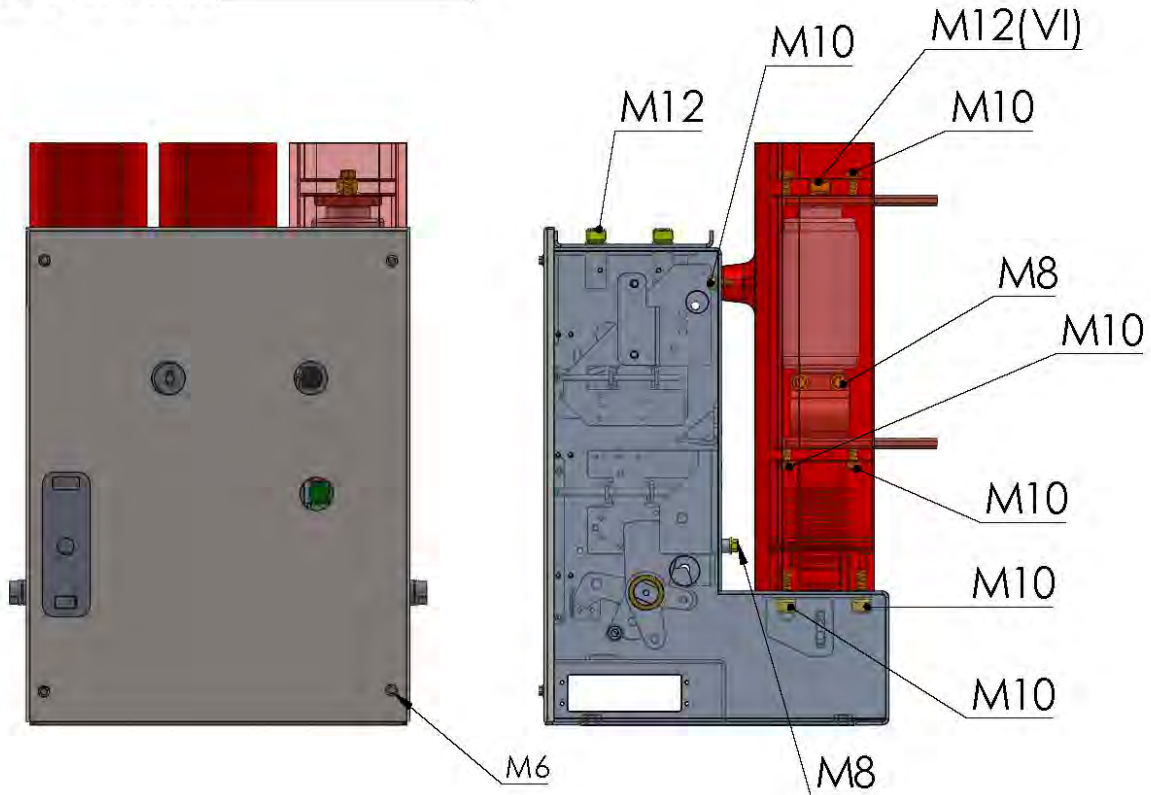

BOLT HEAD SIZE	TORQUE LEVEL(N/M)	CHECKED OK
4.0mm(0.7pitch)	1.9	
5.0mm(0.8pitch)	3.9	
6.0mm(1.0pitch)	6.6	
8.0mm(1.25pitch)	16.0	
10.0mm(1.5pitch)	31.6	
12.0mm(1.75pitch)	55.1	
12.0mm(1.75pitch) (VI)	55.1	

FIGURE 104

Product: CITADEL-Narrow-Drawout **FASTENERS TIGHTNESS TORQUE**

CHECK LIST

RATING :

VCB SERIAL NO:

BOLT HEAD SIZE	TORQUE LEVEL(N/M)	CHECKED OK
4.0mm(0.7pitch)	1.9	
5.0mm(0.8pitch)	3.9	
6.0mm(1.0pitch)	6.6	
8.0mm(1.25pitch)	16.0	
10.0mm(1.5pitch)	31.6	
12.0mm(1.75pitch)	55.1	
12.0mm (1.75pitch) (VI)	55.1	
16.0mm (2.0pitch)	137.0	

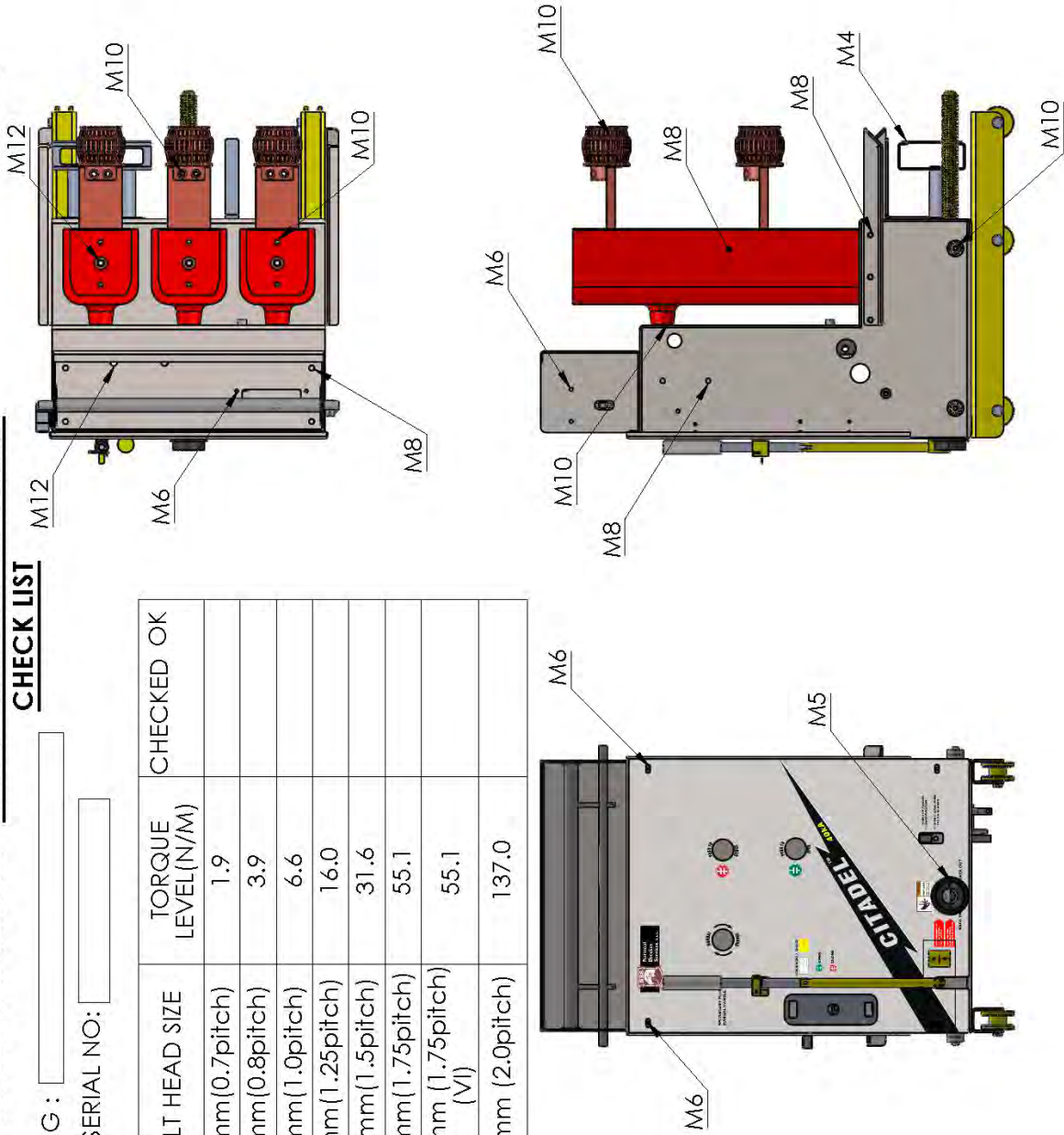

FIGURE 105

Product: CITADEL-Narrow-Drawout

RATING:

VCB SERIAL NO:

FASTENERS TIGHTNESS TORQUE CHECK LIST

BOLT HEAD SIZE	TORQUE LEVEL (N/M)	CHECKED OK
4.0MM (0.7 pitch)	1.9	
5.0mm (0.8 pitch)	3.9	
6.0mm (1.0 pitch)	6.6	
8.0mm (1.25 pitch)	16.0	
10.0mm (1.5 pitch)	31.6	
12.0mm (1.75 pitch)	55.1	
16.0mm (2.0 pitch)	137.0	

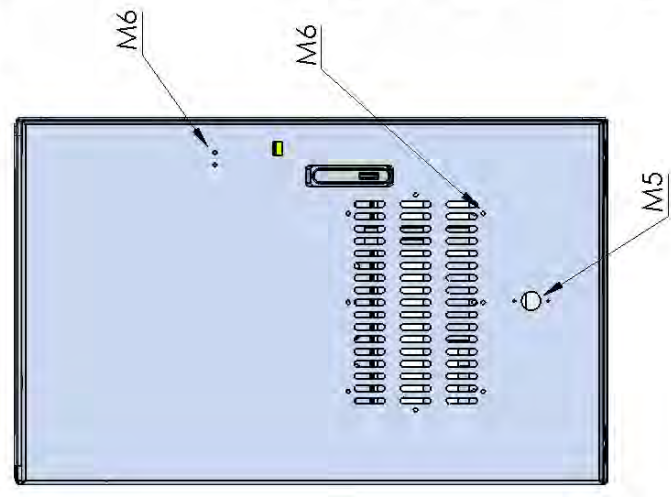
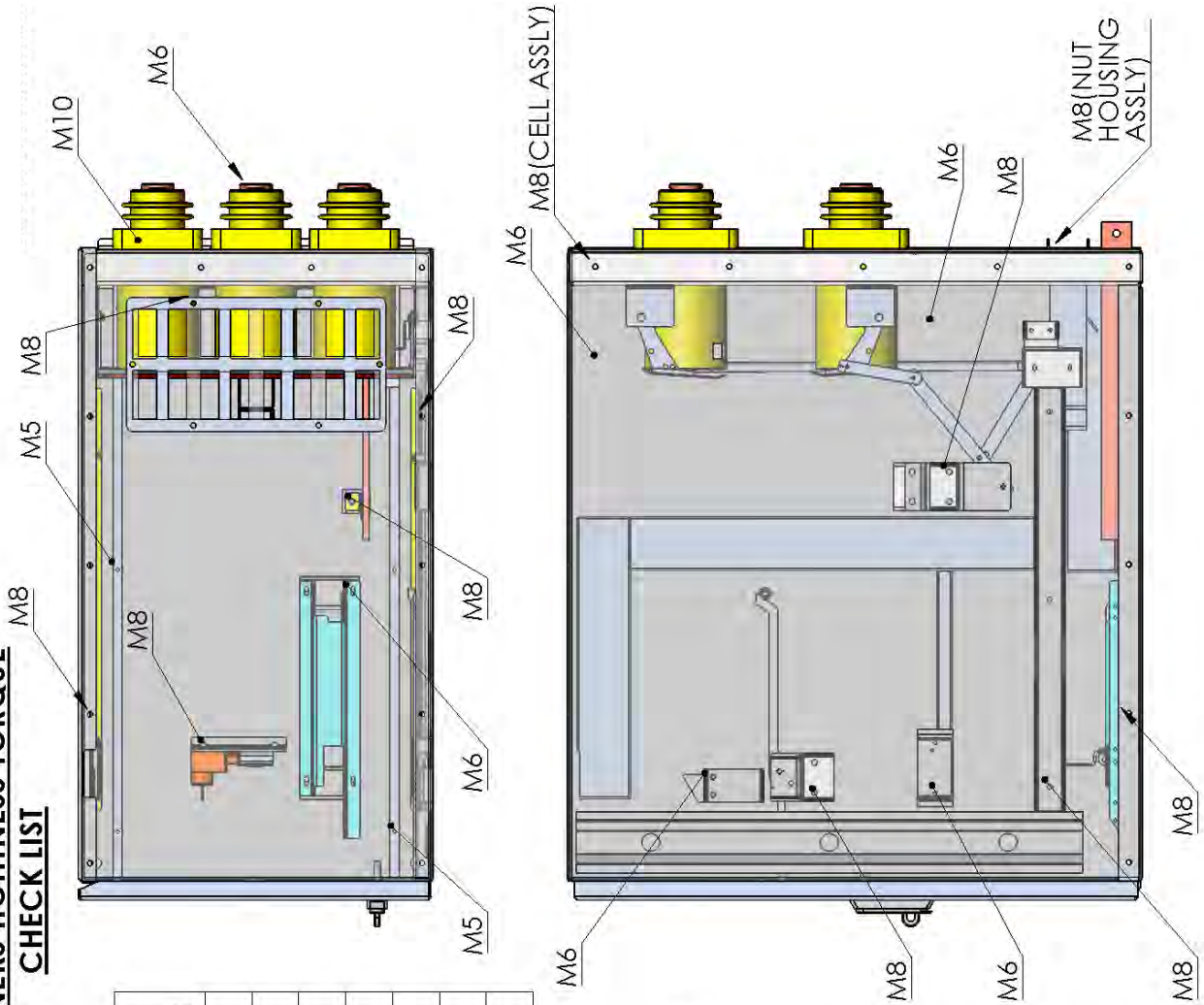

FIGURE 106

Product: CITADEL - 63.0kA - FIXED

FASTENERS TIGHTNESS TORQUE CHECK LIST

RATING:

VCB SERIAL NO:

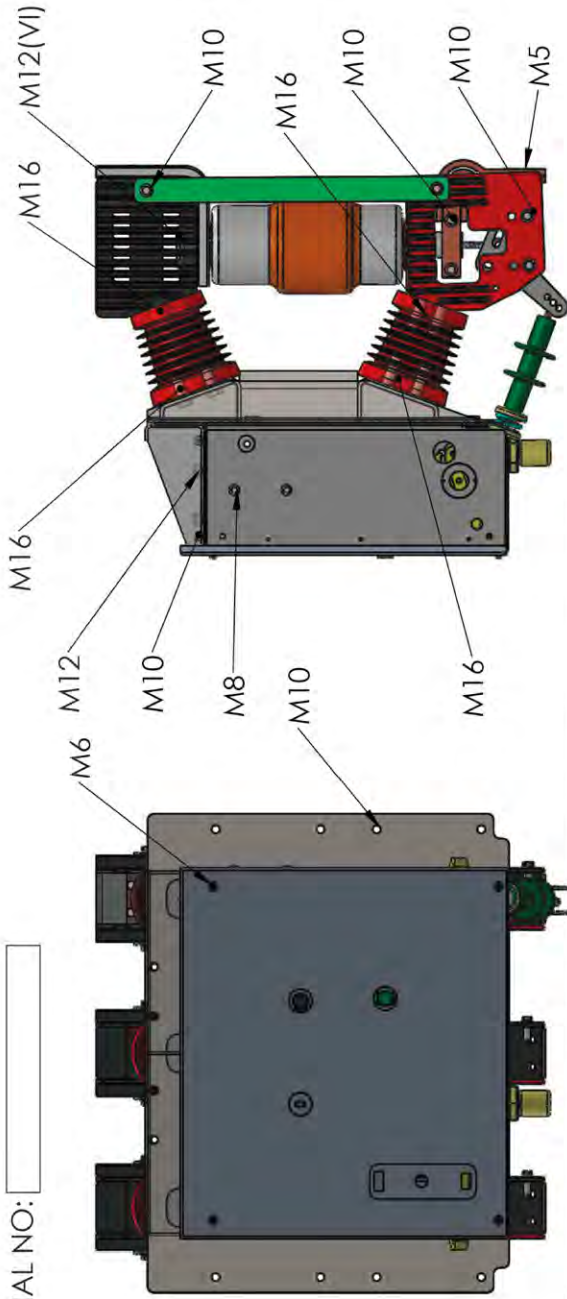

BOLT HEAD SIZE	TORQUE LEVEL(N/M)	CHECKED OK
4.0mm(0.7pitch)	1.9	
5.0mm(0.8pitch)	3.9	
6.0mm(1.0pitch)	6.6	
8.0mm(1.25pitch)	16.0	
10.0mm(1.5pitch)	31.6	
12.0mm(1.75pitch)	55.1	
12.0mm(1.75pitch) (VI)	55.1	
16.0mm (2.0pitch)	137.0	

FIGURE 107

FASTENERS TIGHTNESS TORQUE CHECK LIST

Product: CITADEL-63.0kA Drawout VCB

RATING :

VCB SERIAL NO:

BOLT HEAD SIZE	TORQUE LEVEL(N/M)	CHECKED OK
4.0mm(0.7pitch)	1.9	
5.0mm(0.8pitch)	3.9	
6.0mm(1.0pitch)	6.6	
8.0mm(1.25pitch)	16.0	
10.0mm(1.5pitch)	31.6	
12.0mm(1.75pitch)	55.1	
12.0mm(1.75pitch)(VI)	55.1	
16.0mm(2.0pitch)	137.0	

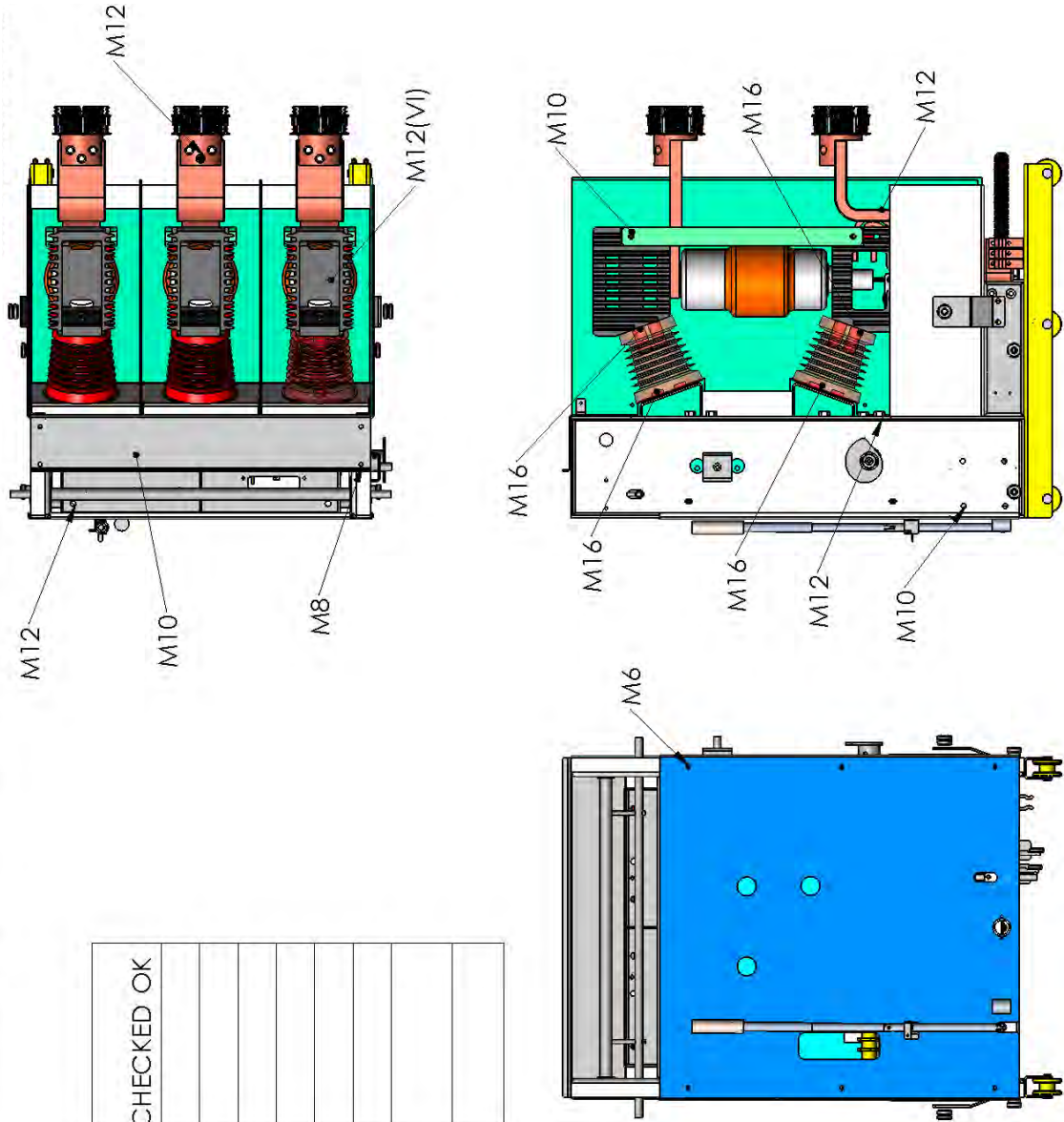

FIGURE 108

FASTENERS TIGHTNESS TORQUE CHECK LIST

RATING:

VCB SERIAL NO:

BOLT HEAD SIZE	TORQUE LEVEL (N/M)	CHECKED	OK
4.0MM (0.7 pitch)	1.9		
5.0mm (0.8 pitch)	3.9		
6.0mm (1.0 pitch)	6.6		
8.0mm (1.25 pitch)	16.0		
10.0mm (1.5 pitch)	31.6		
12.0mm (1.75 pitch)	55.1		
16.0mm (2.0 pitch)	137.0		

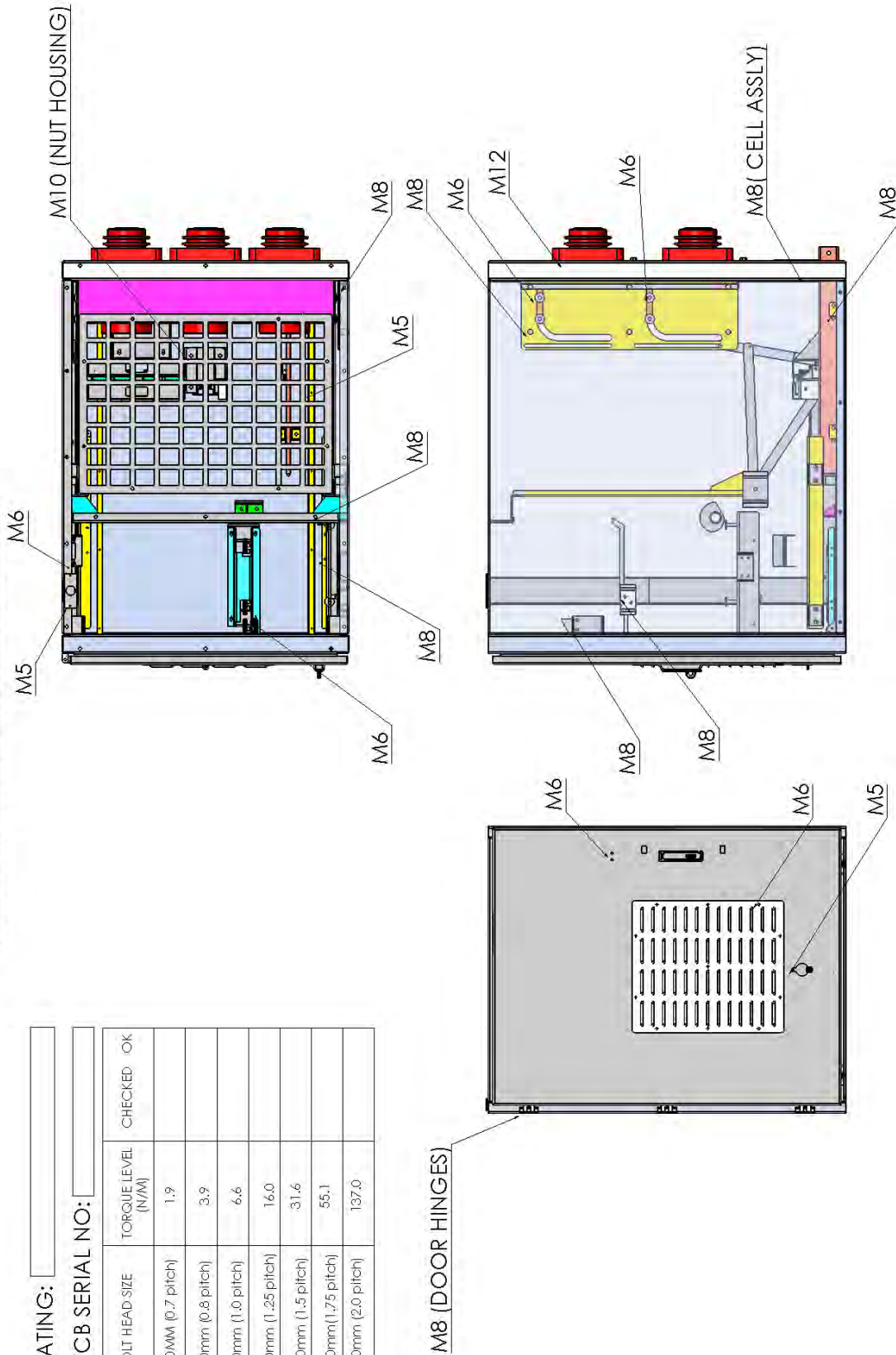

FIGURE 109

M A I N T E N A N C E

THE LISTS AND INTERVAL OF PERIODICAL INSPECTION - TABLE 15

Inspection Items	Description	Interval
General Check	<ol style="list-style-type: none"> 1. Clean the insulated surface with a dry cloth to remove dust and moisture. 2. Check the exterior for damage. 3. Check for loose bolts and nuts in the operating mechanism and the external parts. 4. Check stop ring and stop retainer for damage. 5. Check the connection between terminals and conductors. 6. Check for any thermal over heating 	18 to 36 months (*)
Operation Test	<ol style="list-style-type: none"> 1. Operate a few times manually and electrically and check each part for proper function. 2. Check position indicator and counter for proper function. 	18 to 36 months (*)
Insulation Resistance	<ol style="list-style-type: none"> 1. Measure insulation resistance phase to phase and phase to ground 2. Check insulation resistance between control circuit and ground. Measured value less than specified should be investigated and corrected 	Every 5 years or 2,000 operations. (*) Which ever comes first
Withstand Voltage Test	<ol style="list-style-type: none"> 1. Test the breaker with power withstand voltage as specified 	Every 5 years or 2000 operations. (*) Which ever comes first
Lubrication	<ol style="list-style-type: none"> 1. Lubricate operating mechanism as specified. 2. Clean finger clusters with a dry cloth. Re-grease as specified. 	7 years or 2,000 operations. (*) Which ever comes first
Vacuum Interrupter	<ol style="list-style-type: none"> 1. Check the contact erosion indicator. Replace as specified. 2. Voltage withstand as specified. 3. Micro ohm as specified. 4. Slow close test as specified. 5. Timing test as specified. 	7 years or 2,000 operations. (*) Which ever comes first or after short circuit operations
Control Components	<ol style="list-style-type: none"> 1. Check all control components (including charging motor) via electrical operation over specified ANSI ranges. 	7 years or 2,000 operations. (*) Which ever comes first
(*) If 3 operations of short circuit current occurs perform all above.		
Use unscheduled outage opportunities to clean and inspect breakers and switchgear		

Visual Inspection

The purpose of visual inspection is to check the visible exterior of the breaker in its usual operation and withdrawn positions. Once a year, a general visual inspection should be carried out. The outer insulation parts should be wiped with a rag more frequently if the breakers are exposed to dust.

Annual Inspection Check List

TABLE 16

The Visual Inspection List	
Inspection	Description
Circuit Breaker	Check if position indicator is normal Check for the presence of dust or moisture Check for unusual noise, smell or discoloration Operate breaker electrically
Temperature Rise	Check primary finger clusters or terminals for discoloration or for traces of overheating.

DANGER  Hazardous voltage and high-speed moving parts will cause death, serious injury and property damage.

De-energize all equipment before working on it.

Read instruction manuals, observe safety instructions and **ONLY** allow trained, qualified personnel to engage with this equipment for service, maintenance and operations.

1. Clean circuit breaker, especially post insulators and any insulating couplers.
2. Check all terminal screws.
3. Check all screw connections and locking devices on mechanism parts that looks suspect.
4. Insure all electrical connections are tight and have low electrical resistance values.

Cleanliness check

Figure 11 (page 39) is a side view of the circuit breaker with the insulating barriers removed (if furnished) to show the vacuum interrupter, and the upper and lower connection pads. All of these components must be clean and free of dirt or any foreign objects. Use a dry lint-free cloth. For stubborn dirt, use a clean cloth dipped in isopropyl alcohol (except for the vacuum interrupters). For stubborn dirt on a vacuum interrupter use a cloth and warm water and a small amount of mild liquid-household detergent as a cleaning agent. Dry thoroughly using a lint-free cloth.

Inspection of flexible connectors: Inspect the flexible connectors that connect the bottom movable contacts of the vacuum interrupters to the lower connection pad for tightness and absence of mechanical damage, burning or pitting.

DANGER



Hazardous voltage and high-speed moving parts will cause death, serious injury and property damage.

NEVER bypass interlocks or otherwise defeat interlocks. Interlocks must be in operation at all times.

Read instruction manuals, observe safety instructions and use qualified, trained personnel ONLY.

Automatic spring-charging check (control power required)

Repeat the automatic spring-charging check described in the section describing the installation check and initial functional tests (refer to pages 15 to 21).

1. The circuit breaker must be energized with control power for this check.
2. Energize the control-power source.
3. When control power is connected to the circuit breaker, the motor should immediately operate and the closing spring should automatically charge. Visually verify that the closing spring is charged.

A temporary source of control power may be required when performing maintenance checks out of the switchgear cubicle.

When control power is connected to the circuit breaker, the closing spring should automatically charge.

Electrical close and trip check (control power required)

An energized operational check of the Citadel circuit breaker shall be performed. This check is made with the Citadel breaker in the test position of the switchgear cubicle. The cubicle shall have its control power energized.

1. Once the circuit breaker springs are charged, move the switchgear Close / Trip switch to the Close position. Verify by both the sound of the circuit breaker closing and by the main contact status indicator that the circuit breaker contacts are closed.
2. As soon as the circuit breaker has closed, the automatic spring-charging process is repeated.
3. After a satisfactory close operation is verified, move the switchgear Close / Trip switch to the Trip position. Verify by both the sound of the circuit breaker opening and by the main contact status indicator that the circuit breaker contacts are open.
4. After a satisfactory open operation is verified, hold the circuit breaker manual Trip button and apply and maintain an electrical close signal. The circuit breaker should close, immediately trip, the close spring should charge, and the circuit breaker should not attempt to close again.

Completion of these checks demonstrates satisfactory operation of auxiliary switches, internal relays and open and close coils.

DANGER



Failure to maintain the equipment could result in death, serious injury or product failure and can prevent successful functioning of the connected apparatus.

- Do not work on a breaker in the “connected” position.
- Do not work on a breaker with springs charged or contacts closed.
- Do not leave maintenance tools around the breaker.

While the work is in progress, all auxiliary voltage sources must be disconnected.

Recommended maintenance and lubrication;

Periodic maintenance and lubrication should include all the tasks as described in this manual.

Recommended procedures for each of the listed tasks are provided in this section of the instruction manual.

The list of tasks does not represent a complete listing of every maintenance step necessary to ensure safe operation of the equipment under every condition.

Particular applications and environments will require further analysis of maintenance procedures.

Seek further information if you have ANY questions or should problems arise that are not considered to be sufficiently covered herein. Any questions should be referred to the Factory for full explanation and clarification.

Inspection items checklist

TABLE 17

(1) Cleanliness check
(2) Inspection and cleaning of circuit-breaker insulation
(3) Manual-spring charging check
(4) Fastener check
(5) Wiring and terminals checks
(6) Secondary-disconnect check (drawout only)
(7) Stored-energy operator-mechanism checks
(8) Auxiliary Switch (10 NO +10NC)
(9) Automatic spring-charging check
(10) Electrical-control checks
(11) Electrical close and trip check
(12) Control circuits insulation test
(13) Primary-power path checks
(14) Vacuum-integrity check
(15) High-potential test
(16) Inspection of flexible connectors
(17) Contact-resistance test
(18) Functional tests
(19) Maintenance and lubrication
(20) Contact-erosion check

Hardware check

Inspect all fasteners for tightness. The Citadel mechanism uses both locknuts and retaining rings. Replace any fasteners that appear to be unusually loose, worn, misshapen or in other ways questionable.

Manual spring-charging and contact erosion checks

Perform the manual spring-charging check contained in the section describing the installation check and initial functional tests (refer to page 17).

Spring Charging Motor

Operationally check the spring-charging motor via electrical operation. If operating smoothly - no additional checks of the spring charging motor are necessary.

If it should ever become necessary to replace the spring charging motor; motor-mounting hardware should be torqued to 7.3-8 ft-lb (10-11 NM for 6.0 mm 8.8 grade bolt).

Anti-pump relay

Should it ever be necessary to remove the connections to the anti-pump relay, use care to avoid damaging the relay and wiring connections.

Replace the relay if the relay terminals are damaged or loose in the relay body.

Vacuum interrupters

The life expectancy of vacuum interrupters is a function of the numbers of interruptions and magnitude of current interrupted (refer to Vacuum Bottle Life graphs Figure 8, Page 34).

Vacuum interrupters must be replaced;

- before the number of mechanical operations (Figure 8, Page 34 and Figure 9, Page 36) are reached,
- when the contacts have been eroded beyond allowed limits
- or the interrupter(s) does not pass appropriate power frequency voltage withstand testing.
- if the VI exhibits un-acceptably high and or unbalanced micro-ohm readings

Vacuum interrupter replacement procedures are available from the factory as separate detailed sets of maintenance instructions.

Contact the factory to obtain instructions for your specific make, model and rating of breaker and power pole design.

At that time, also check with the factory if video instructions are available to supplement your understanding and maintenance efforts.

For vacuum interrupter replacement –

Customers should have maintenance procedures done by the factory or factory trained field services personnel only.

ONLY factory NEW vacuum interrupters are to replace existing Citadel interrupters. Always consider replacing vacuum interrupters as a set.

Except for hardware;

NEVER use any parts on a Citadel other than NBS supplied factory new.

Vacuum-integrity check (using mechanical test) (refer to Figure 111, page 125)

Before putting the circuit breaker into service, or if a vacuum interrupter is suspected of leaking as a result of mechanical damage, check the vacuum integrity either mechanically as described in this section, or electrically using a high-potential test set as described in the next section.

Open and isolate the circuit breaker and detach the vacuum interrupter’s insulated push rod from lower moving stem lever.

Normal atmospheric pressure will force the moving contact of a sealed vacuum interrupter into the “Closed “position.

A vacuum interrupter may be assumed to be intact if it shows the following characteristics:

A significant closing force is exerted on the sealed interrupter, requiring much effort to overcome when attempting to pull the lower Vacuum interrupter’s stem to the “Open” position by hand (Figure 111, page 125);

1. When the lower moving stem linkage is released, it must automatically return to the “Closed “position with an audible sound as the contacts touch.

After checking the vacuum, reconnect the linkage lever to the push rod assembly (Figures 110A and 110B, page 121).





THIS QR CODE WILL LINK TO A DEMONSTRATION VIDEO

Vacuum-integrity check can be performed by doing an elevated voltage (high-potential) test.

These instructions assume these tests (contact-erosion/ manual spring-charging check and vacuum-integrity/high-potential tests) will be combined as described.

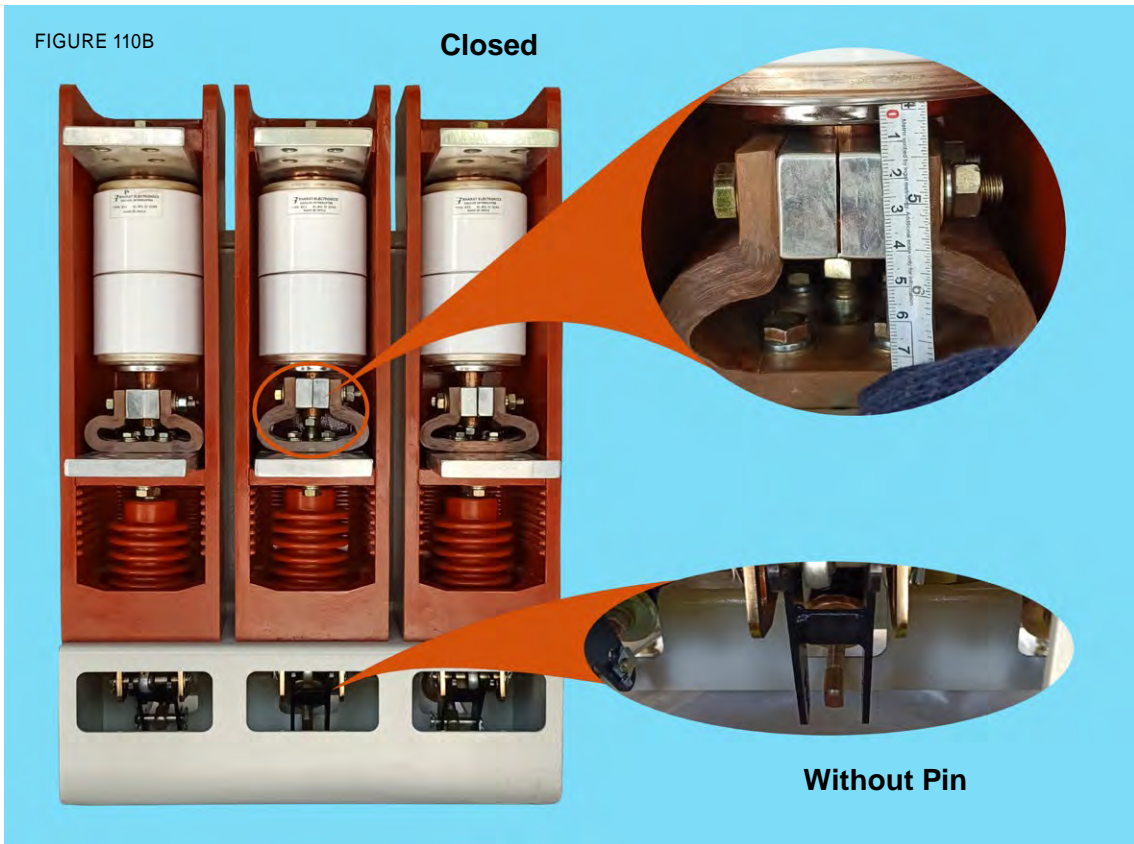
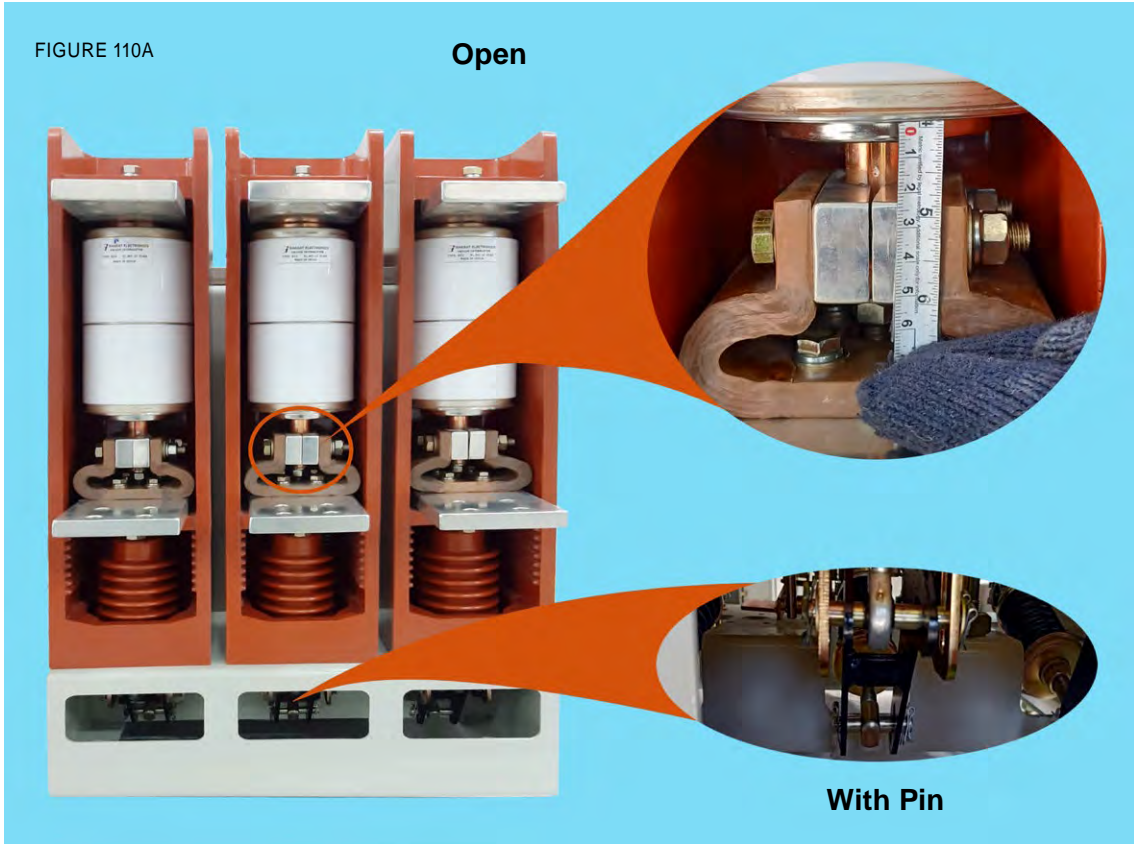
	<p>DANGER High-potential tests employ hazardous voltages which will cause death and serious injury.</p>
	<p>Follow safe procedures, and use safety barriers. Keep away from the circuit breaker during application of test voltages.</p>
	<p>Disconnect the moving secondary connector between the circuit breaker and switchgear before conducting high-potential tests.</p>



	<p>WARNING Vacuum interrupters may emit X-ray radiation</p> <p>This can result in serious injury. Keep personnel more than six feet away from a circuit breaker under test.</p>	
---	---	---

High-potential tests;

Vacuum-integrity test and insulation tests involve the use of high-voltage test equipment.

The circuit breaker under test should be inside a suitable test barrier equipped with warning lights.

Vacuum-integrity check;

A high-potential test is used to verify the vacuum integrity of the Citadel circuit breaker. The test is conducted on the circuit breaker with its primary contacts in the Open position.

Vacuum integrity test procedure

1. Observe safety precautions listed in the danger and warning advisories.
2. Know the test equipment and its operating practices. Only trained personnel should attempt to perform High Potential tests.
3. Construct a proper barrier perimeter around the test specimen and a warning light system.
4. Ground the frame of the circuit breaker. Ground each pole not under test.
5. Apply test voltage of 27kV (refer to Table 17) across each “Open” pole for one minute.
6. If the pole sustains the test voltage for that period, its vacuum integrity has been verified.

Note: Do not use dc high-potential testers incorporating half-wave rectification. These devices produce high peak voltages. High peak voltages will produce X-ray radiation. DC testers producing excessive peak voltages also show erroneous readings of leakage current when testing vacuum circuit breakers.

High-potential test voltages

The voltages for high-potential tests are shown in Table 18 (page 123).

Note: This test includes not only the vacuum interrupter, but also the other insulation components in parallel with the vacuum interrupter. These include the post insulators and the insulating coupler, as well as the insulating push rod assemblies and the vacuum interrupter supports. If these insulation components are contaminated or defective, the test voltage will not be sustained. If so, clean and / or replace the affected components and retest.

Equipment maximum voltage rating kV	Equipment rated power-frequency withstand kV (rms)	Maximum ac rms test voltage kV	Maximum dc average test voltage
4.76	19	14	20
8.25	36	27	38
15.0	36	27	38
15.5	50	38	53

TABLE 18

As-found insulation and contact resistance tests;

As-found tests verify the integrity of the circuit breaker insulation system. An insulation resistance test (colloquially known as a Megger*) and contact resistance test should be conducted on equipment prior to installation to provide a base line for future comparison. Over time detecting changes in these values provided clear indication of diminished strength of the insulation system. A permanent record of periodic as-found tests enables the maintenance organization to determine when corrective actions are required by watching for significant deterioration in insulation resistance, or increases in contact resistance.

* Megger is a Brand name registered trademark.

Insulation and contact-resistance test equipment;

In addition to the high-potential test equipment capable of test voltages as listed in Table 19 (page 124), the following equipment is also required:

An insulation resistance tester with variable test voltages of, 1,500 to 5,000 volts. 100 or 200 Amp filtered output continuous current micro-ohm.



WARNING The use of unauthorized parts in the repair of the equipment, or tampering by unqualified personnel can result in hazardous conditions, that can result in death, serious injury or property damage.



WARNING The use of unauthorized parts in the repair of the equipment, or tampering by unqualified personnel will void all warranties. Follow all safety instructions contained herein.

Checking the primary power path;

The primary power path pole assembly consists of the three vacuum interrupters in an insulated molded mounting assembly for 6” pole spacing breakers. A primary power paths are open air heatsink clamped VI’s for 10” centers. For drawout Citadel breakers, each pole assembly has an upper and lower moving primary disconnect (finger cluster).

These components should all be checked for cleanliness and condition. Finger clusters should be checked for strength of spring tension and should have conducting grease applied.

The vacuum interrupters are also checked for vacuum integrity.

To perform the contact-erosion check – it may be a good practice to couple this with the manual spring-charging check of the operator, since charging of the spring is necessary to place the contacts in the CLOSED position.

Note – depending on the way the Citadel element is mounted– especially when using a fixed Citadel element for vacuum conversion of legacy air and oil breakers – it may not be possible to see the contact erosion dot.

TABLE 19

15KV	Closing data		Opening Data (ms)			Contact Resistance	Contact Resistance MAX
	Closing time	Pole spread	Main contact part	Pole spread	Open coil Res (Ohm)		
1200A	< 60 ms at rated Aux voltage	< 2.0 ms.	< 50 ms at Rated aux voltage	< 2.0 ms.	44..0 Ω (125v DC)	< 40 μΩ	Plus 100%
2000A	< 60 ms at rated Aux voltage	< 2.0 ms.	< 50 ms at Rated aux voltage	< 2.0 ms.	44..0 Ω (125v DC)	< 40 μΩ.	Plus 100%
3000A	< 60 ms at rated Aux voltage	< 2.0 ms.	< 50 ms at Rated aux voltage	< 2.0 ms.	44..0 Ω (125v DC)	< 40 μΩ.	Plus 100%
4000A	< 60 ms at rated Aux voltage	< 2.0 ms.	< 50 ms at Rated aux voltage	< 2.0 ms.	44..0 Ω (125v DC)	< 25 μΩ	Plus 100%

1. Perform the contact-erosion check.
Contact erosion occurs when high fault-currents are interrupted.
Determination of contact wear condition is checked by viewing the contact-erosion dot (Figure 111).
The contact-erosion dot is located on the vacuum interrupter's movable stem near the guide-bushing.

Contact erosion dot check procedure;

- a. Be sure the Citadel circuit breaker is “Closed”.
 - b. Observe the white contact-erosion dot (Figure 111) of each pole.
If any amount of the contact-erosion dot is visible, contact wear is within acceptable limits.
2. Manually press the Open pushbutton on the Citadel after completing the contact-erosion check. Visually verify the closing spring has “Discharged” and that the Citadel circuit breaker is “Open”.
3. Press the Close pushbutton. Nothing should happen.
The manual spring check should demonstrate smooth operation of the operating mechanism.
Electrical control checks The electrical controls of the circuit breaker should be checked during inspections to verify absence of any mechanical damage, and proper operation of the automatic spring-charging and Close and Trip circuits.
Unless otherwise noted, all of these tests are performed without any control power applied to the circuit breaker.
- Check of the wiring and terminals
- a. Physically check all of the circuit breaker wiring for evidence of abrasion, cuts, burning or mechanical damage.
 - b. Check all terminals to be certain they are solidly attached to their respective device.

FIGURE 111 - CONTACT-EROSION CHECKMARK DOT
CIRCLED IN ORANGE
(SHOWN WITH CIRCUIT BREAKER OPEN)

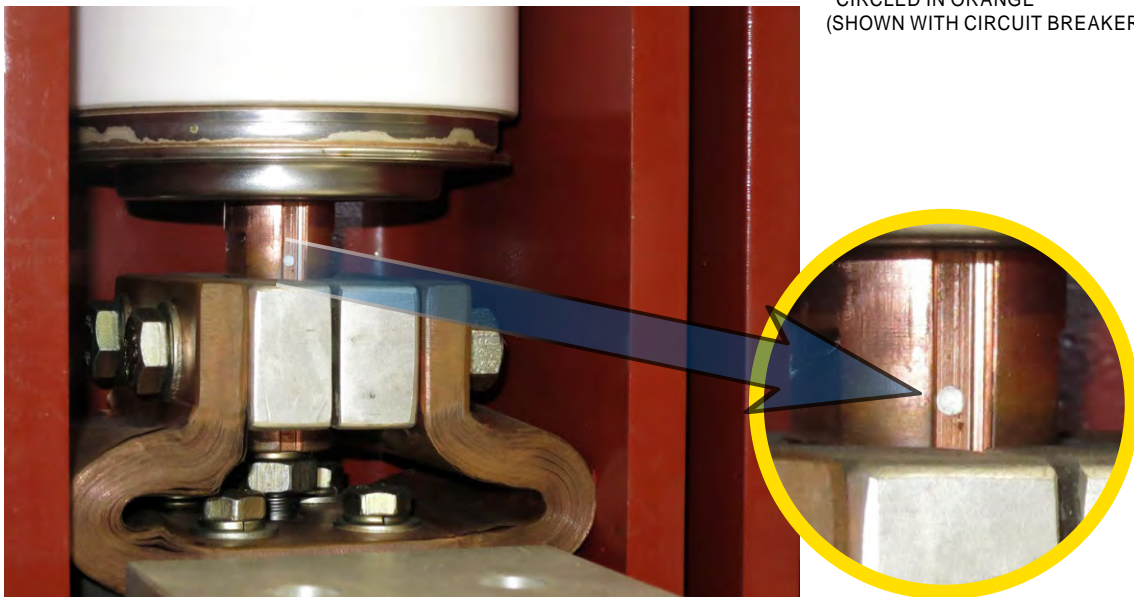

Contact Erosion Continued

Draw out breakers often have run-backs and finger clusters that impede direct visualization of the VI contact erosion dot. In such cases a simple alternative test can be performed with a “Citadel erosion wear tool” .

Properly trained O&M personnel can use this simple go / no go gauge type device and “attempt” to insert it in the gap between the Main Armature Shaft and the sliding bar assembly at the bolted connection point between the breaker VI push rod assembly (page 25 - drawing 3, item #11) and the Breaker Main Armature Shaft (page 40 - figure#14, item # 11).

The gap should be such that the tool will NOT insert into the gap. Upon erosion of the VI contacts by 3mm or greater – the enlarged gap will allow insertion of the tool and thereby demonstrate that end of life wear has been reached for the VI.

In these QR code video scenarios (one per phase) we have assume a FAILED interrupter and therefore the gauge tool allows for insertion into the gap.

The tool should normally NOT fit into the gap if the VI is OK.

The Citadel VI wear tool gauge should be 26.5 mm and if the VI IS GOOD the tool should NOT fit in the opening when the breaker is closed.

This INABILITY to insert the tool into the gap shows that the VI has LIFE left to it from the point of view of wear.

As the VI contacts wear down – that gap between the top of the switching bar (the top of the push rod) and the Main Shaft will grow.

As that gap grows – when you get to 26.5 mm or a little larger and the tool then fits into the gap – at that time the VI is worn down beyond that allowable 3mm and should be replaced.

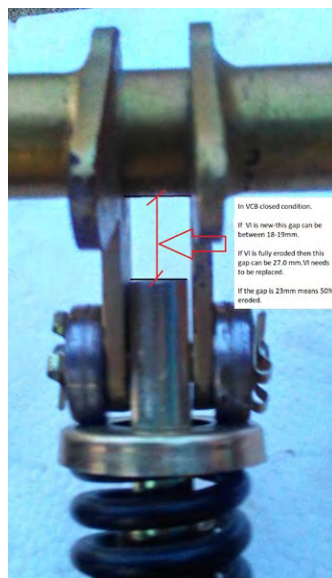

FIGURE 111-B



FIGURE 111-C

Note:

The testing procedure is identical for all three phases.
The videos are more or less identical – each depicting either Phase A - B or C.
The purpose is to show that a normal size arm with tool in hand can reach the measuring point relatively unimpeded.

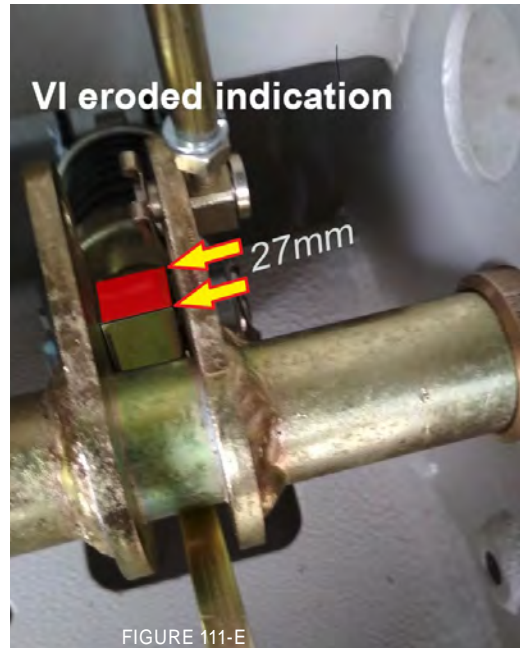

QR Video scann code.
The video shows tests
performed using the
Citadel® erosion wear tool.

CAUTION



Failure to maintain the equipment could result in death, serious injury or product failure and can prevent successful functioning of the connected apparatus.

- Do not work on a breaker in the “connected” position.
- Do not work on a breaker with springs charged or contacts closed.
- Do not leave maintenance tools around the breaker.
- While the work is in progress, all auxiliary voltage sources must also be disconnected.

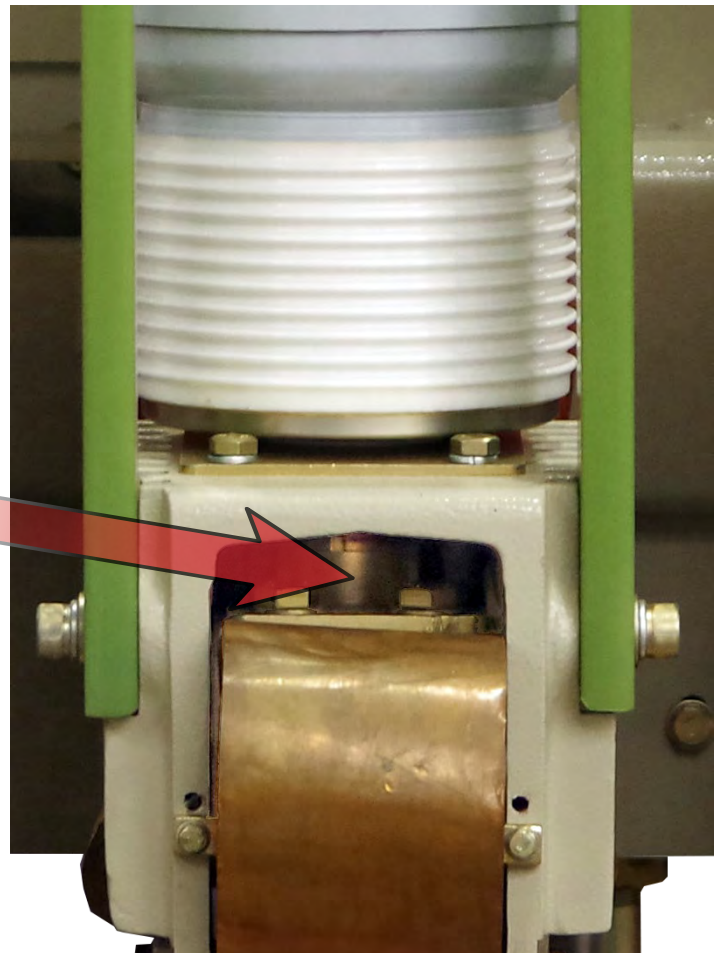
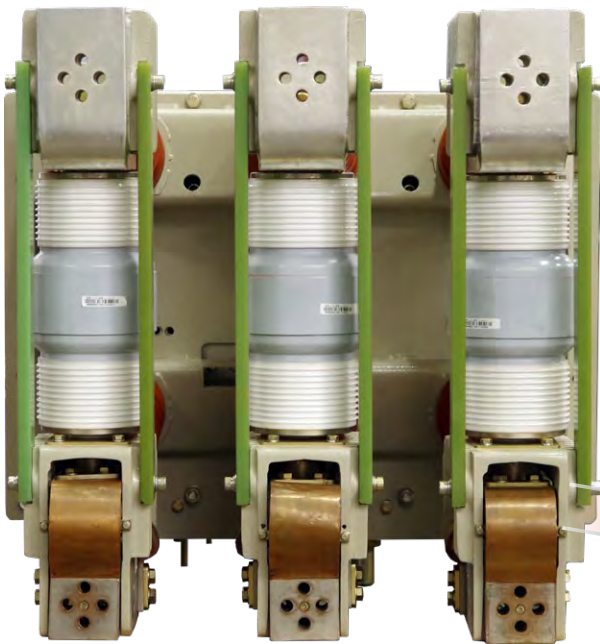

FIGURE 112

Since the contacts are contained inside the vacuum interrupter, they remain clean and require no maintenance.

Maximum permitted erosion is 3 mm.

LUBRICATION

Maintenance and lubrication

This section provides recommended information for Citadel circuit breaker and cell lubrication.

This information is based upon the Citadel circuit breaker operating under “usual service conditions” as per ANSI / IEEE 37.20.2, section 4 (for drawout circuit breakers) or ANSI / IEEE C37.04.

This information is based upon the Citadel circuit breaker operating in clean environments.

Maintenance and lubrication intervals are based on the number of closing operations or the time interval since last maintenance whichever occurs first.

Generally seven (7) years or 2000 operations should be scheduled as maintenance cycle points.

Any fault operations that impinge upon VI life curves boundaries should be scheduled as maintenance cycle points.

Clean the entire stored-energy operator mechanism and the connector points of often moving parts with a dry, lint-free cloth. Using compressed air (such as a keyboard cleaner) can be a useful assistant.

Carefully check all components for evidence of noticeable wear. Pay additional attention to the closing spring-crank and the insulating couplers and linkages as they see much of the mechanical forces of operation.

For all lubrication (except electrical moving or sliding surfaces), use one of the following:

TIMKEN Fleetultra Grease (olive green).

CRC® Power Lube® (spray) (part 03045).

Lubrication Points - Citadel™ Breaker Element

FIGURE 35B - OPERATOR MECHANISM LUBRICATION - LUBRICANT SECTORS

FIGURE 113

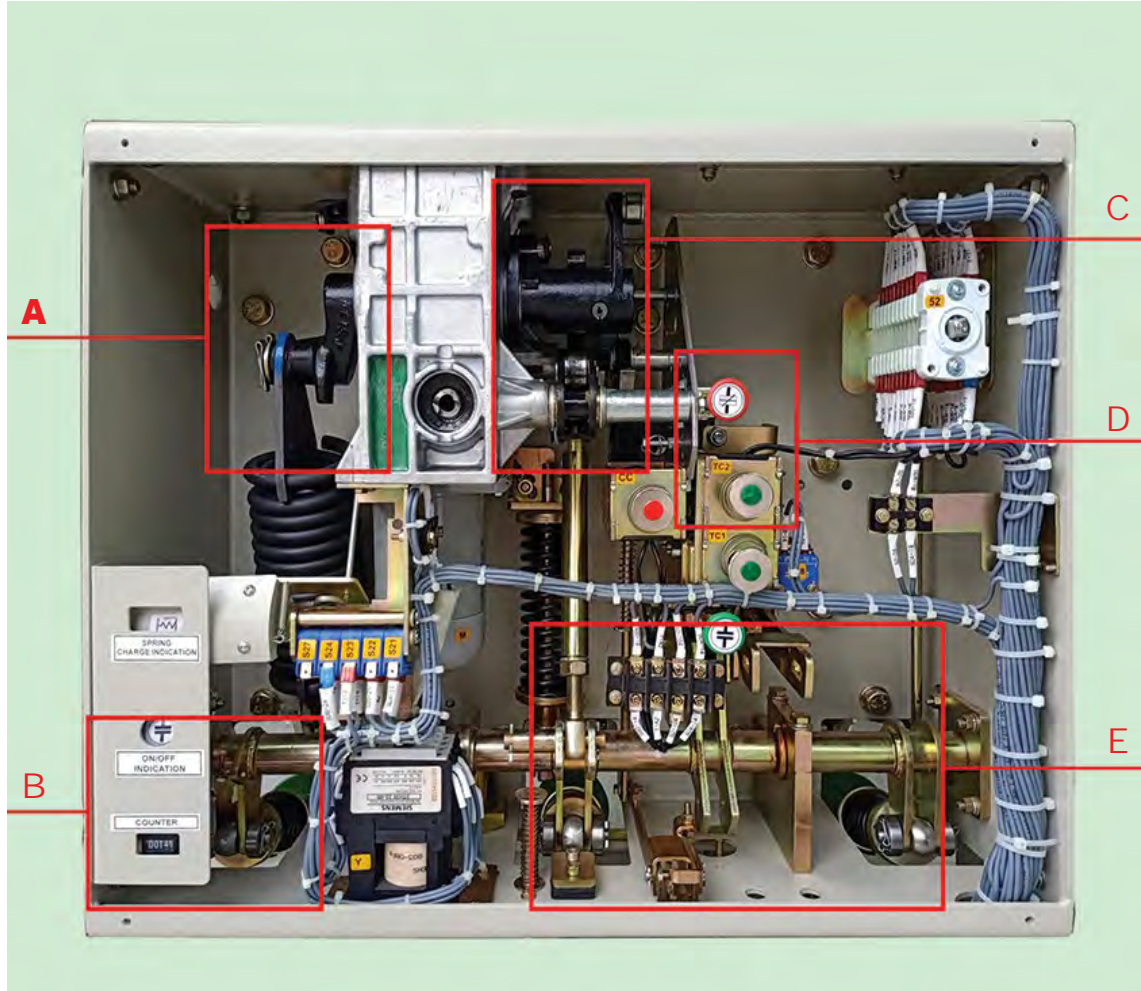

FIGURE 114

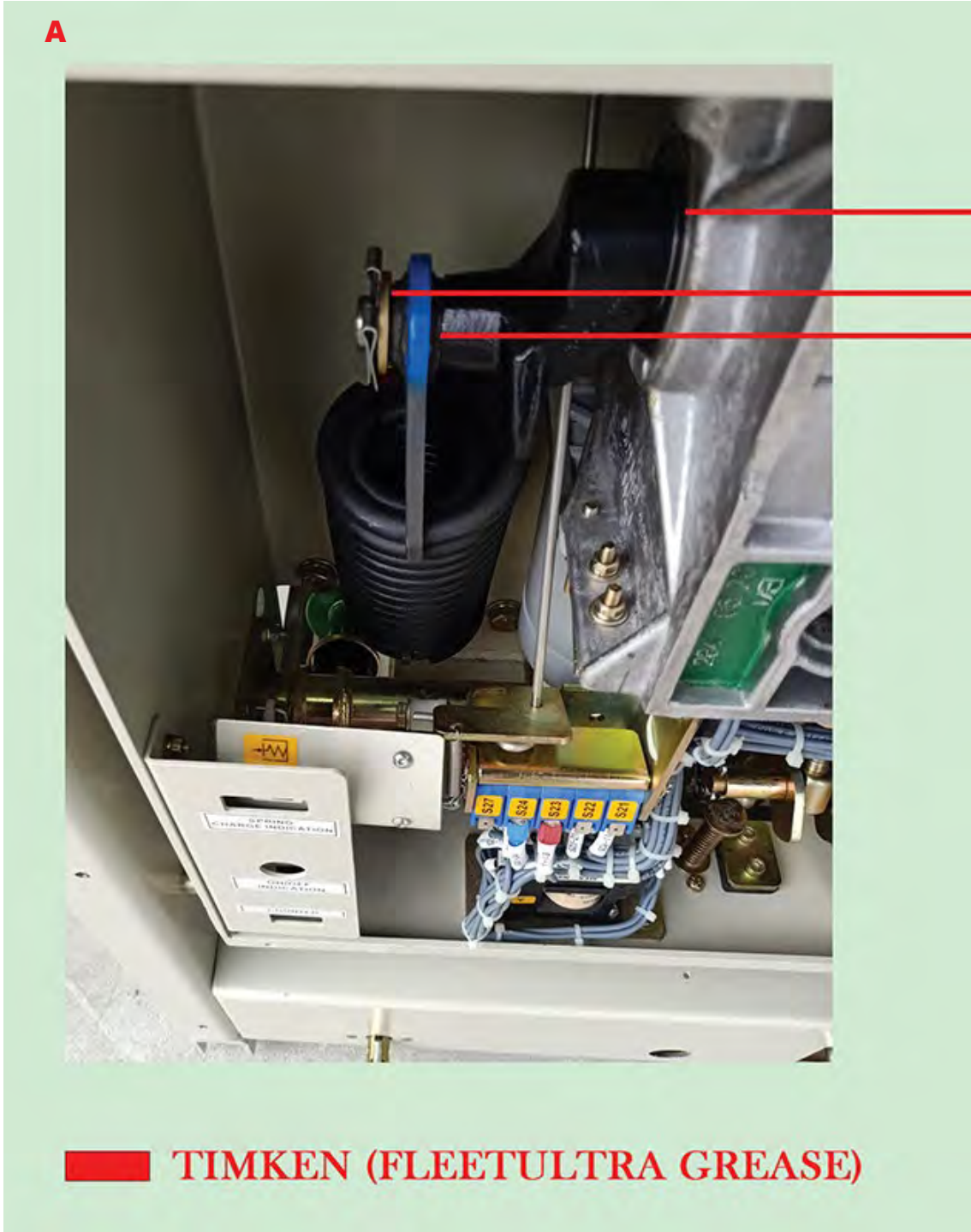

FIGURE 115

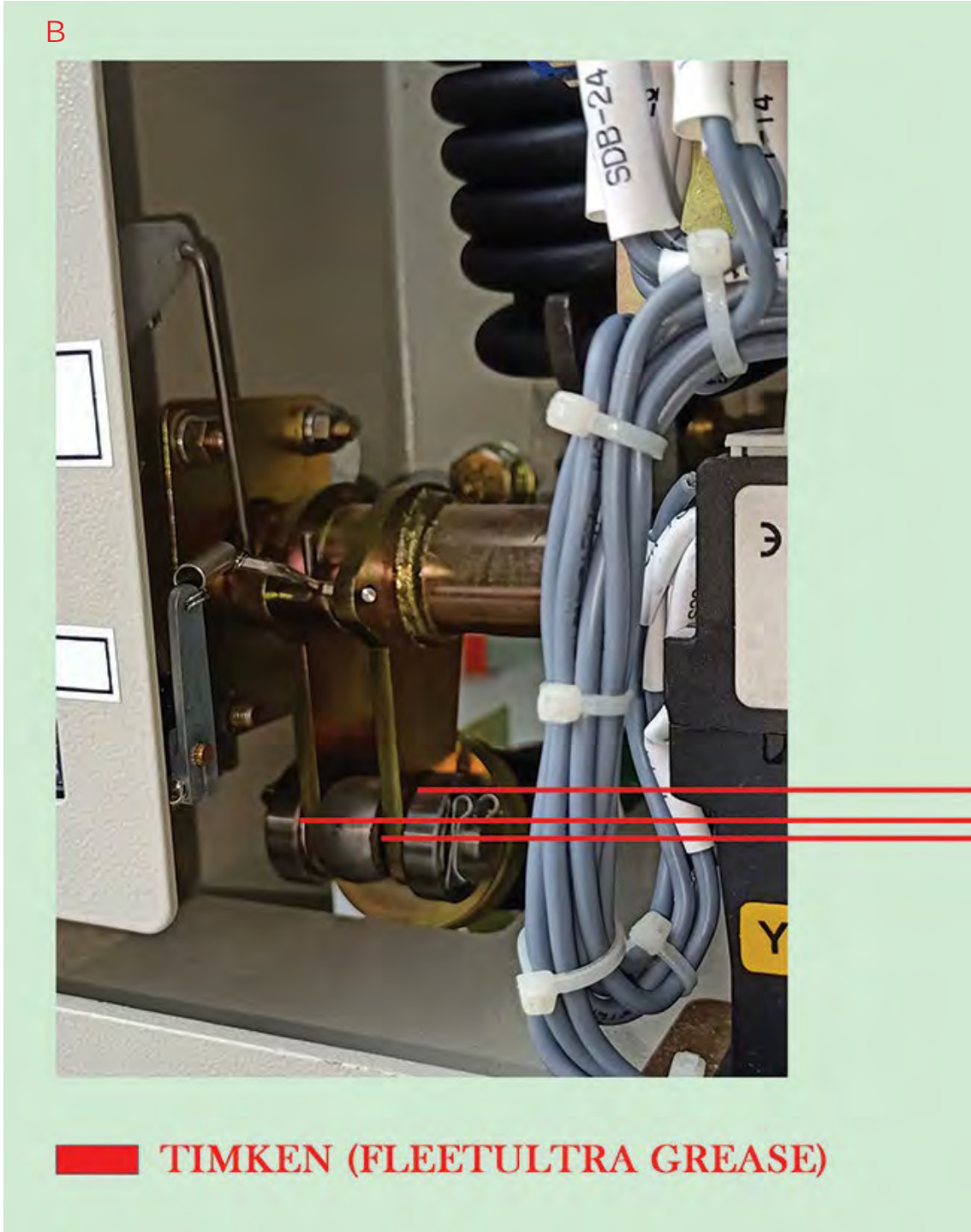

FIGURE 116

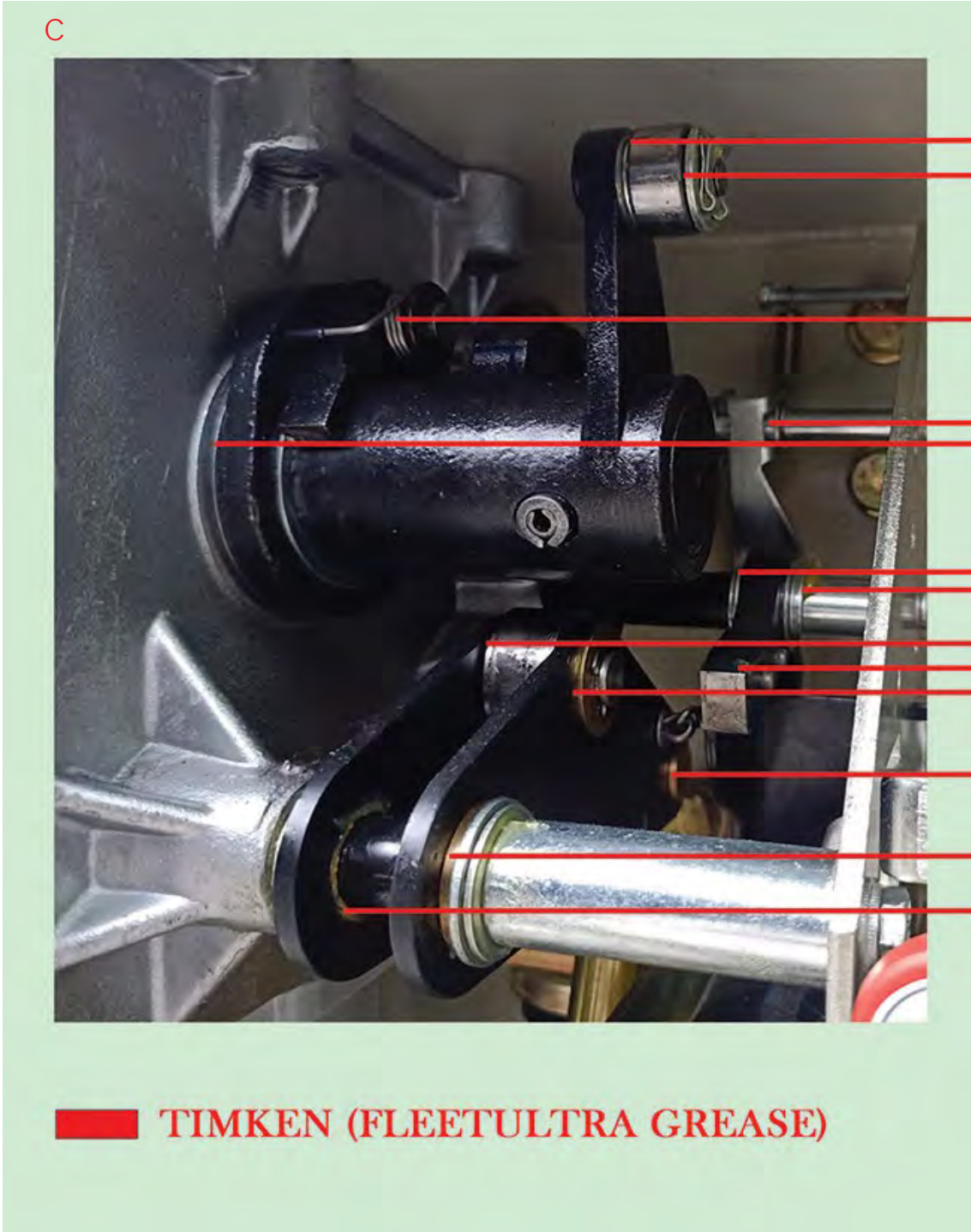

FIGURE 117

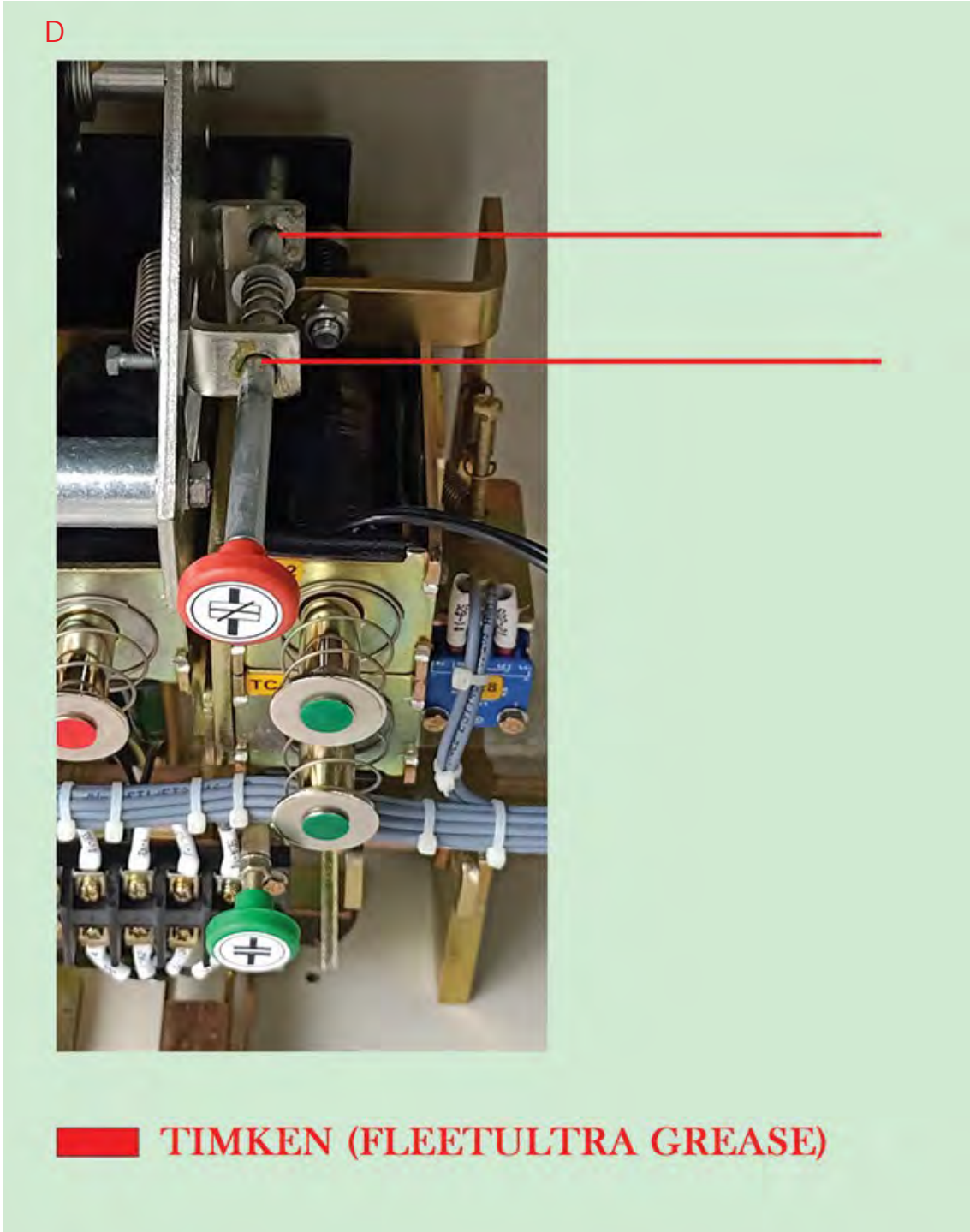

FIGURE 118

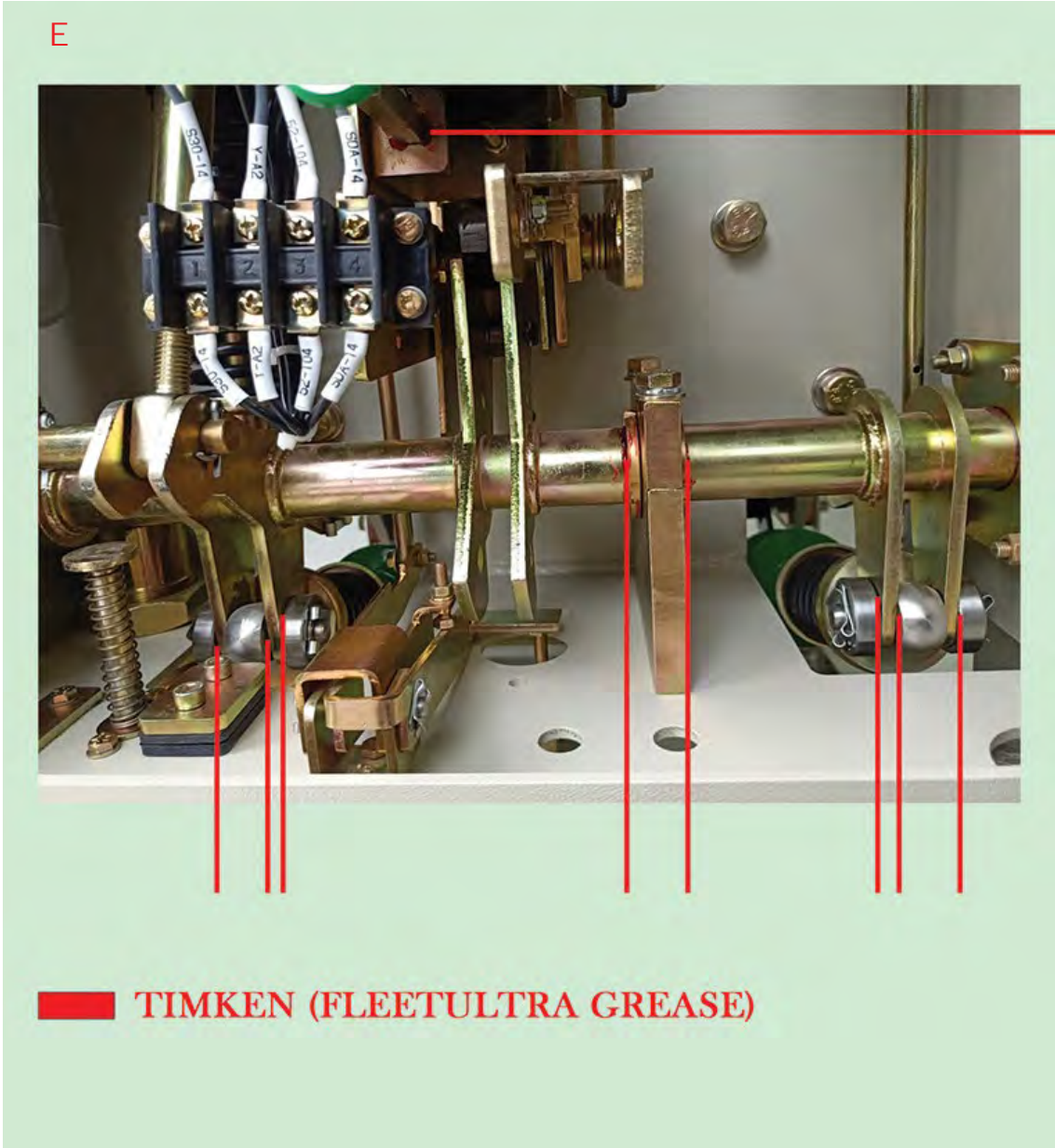

FIGURE 119

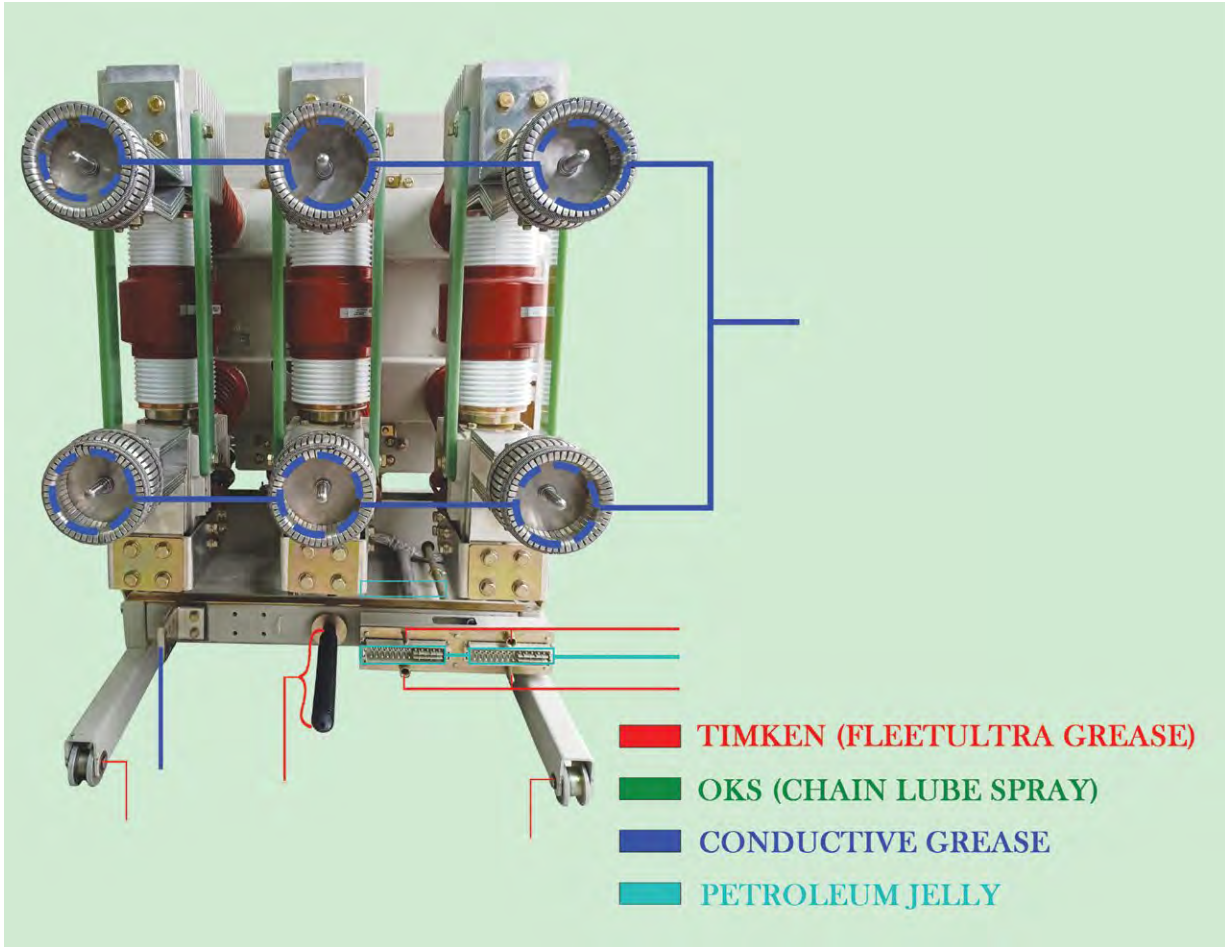

FIGURE 120

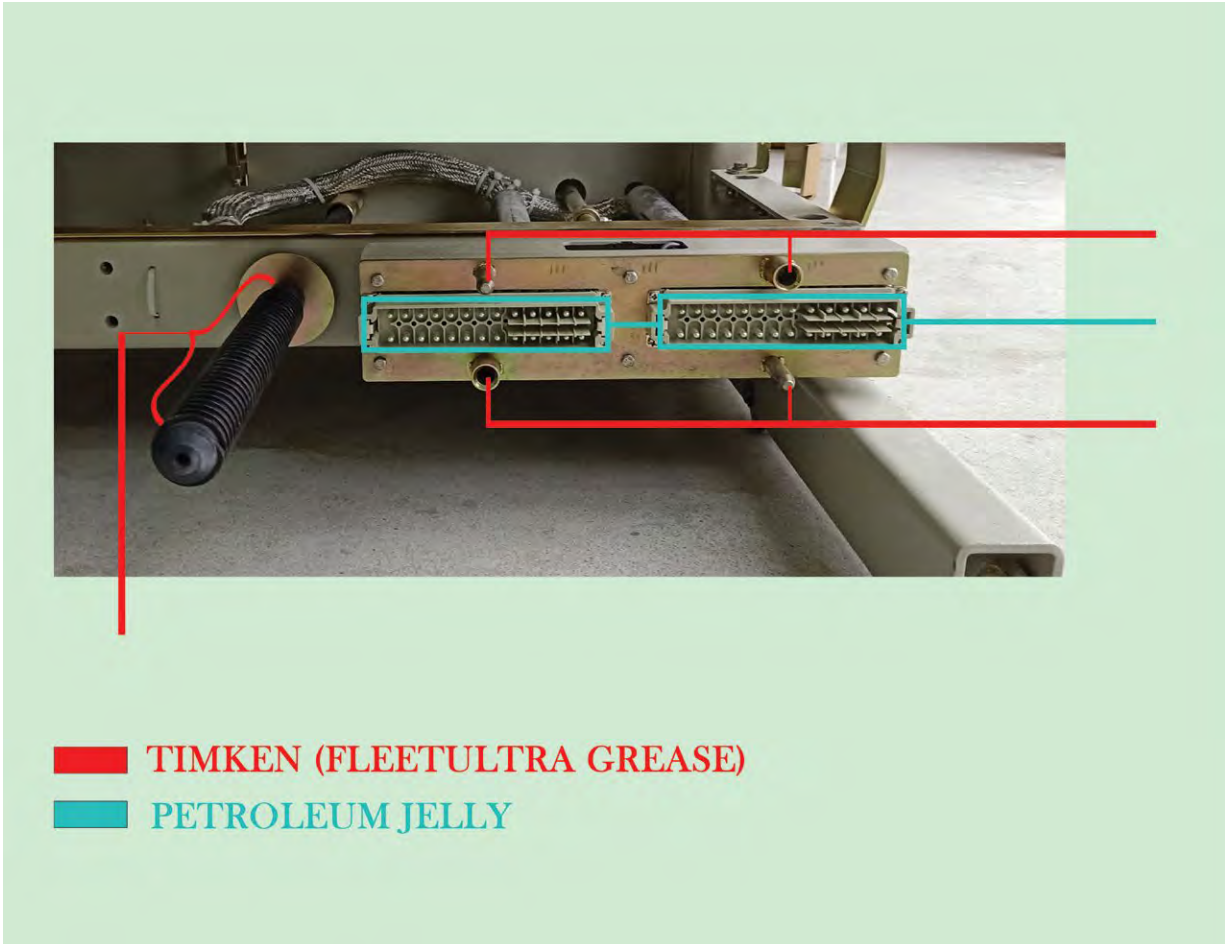

FIGURE 121

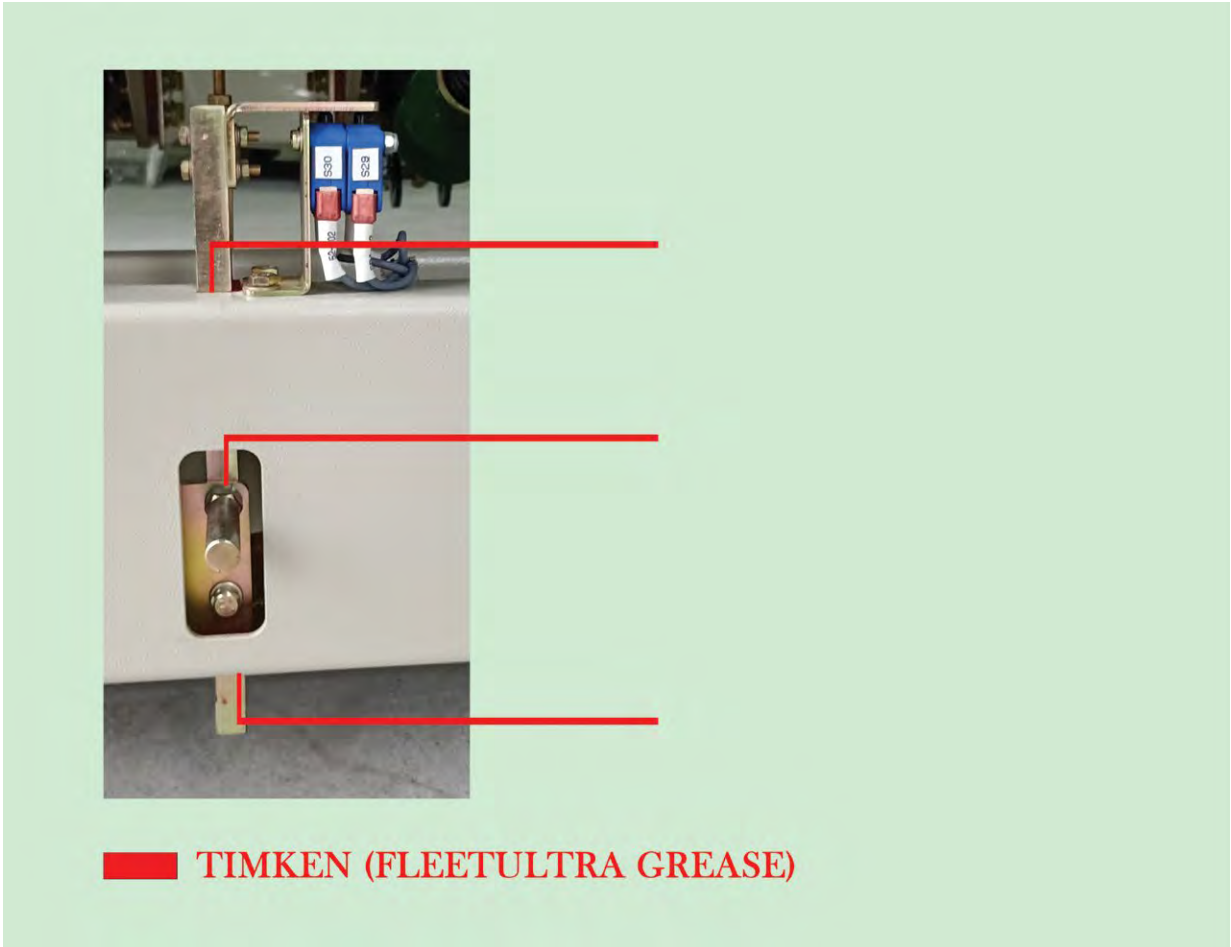
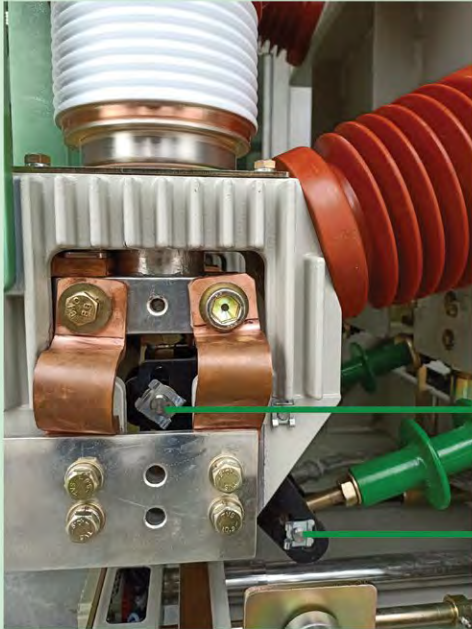
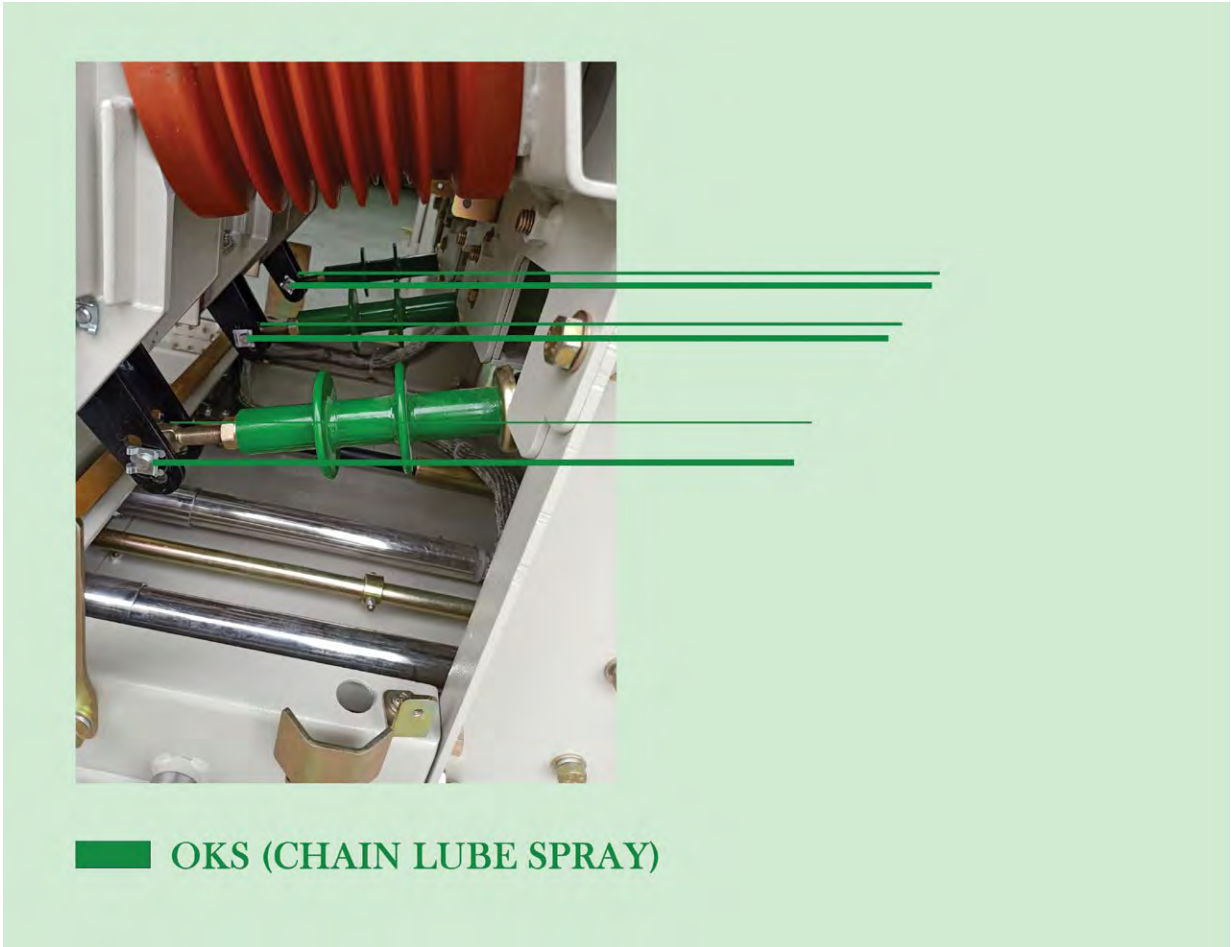

FIGURE 122



■ OKS (CHAIN LUBE SPRAY)

FIGURE 123



Lubrication Points - Switchgear Cell

FIGURE 35B - CELL LUBRICATION - SECTORS

FIGURE 124

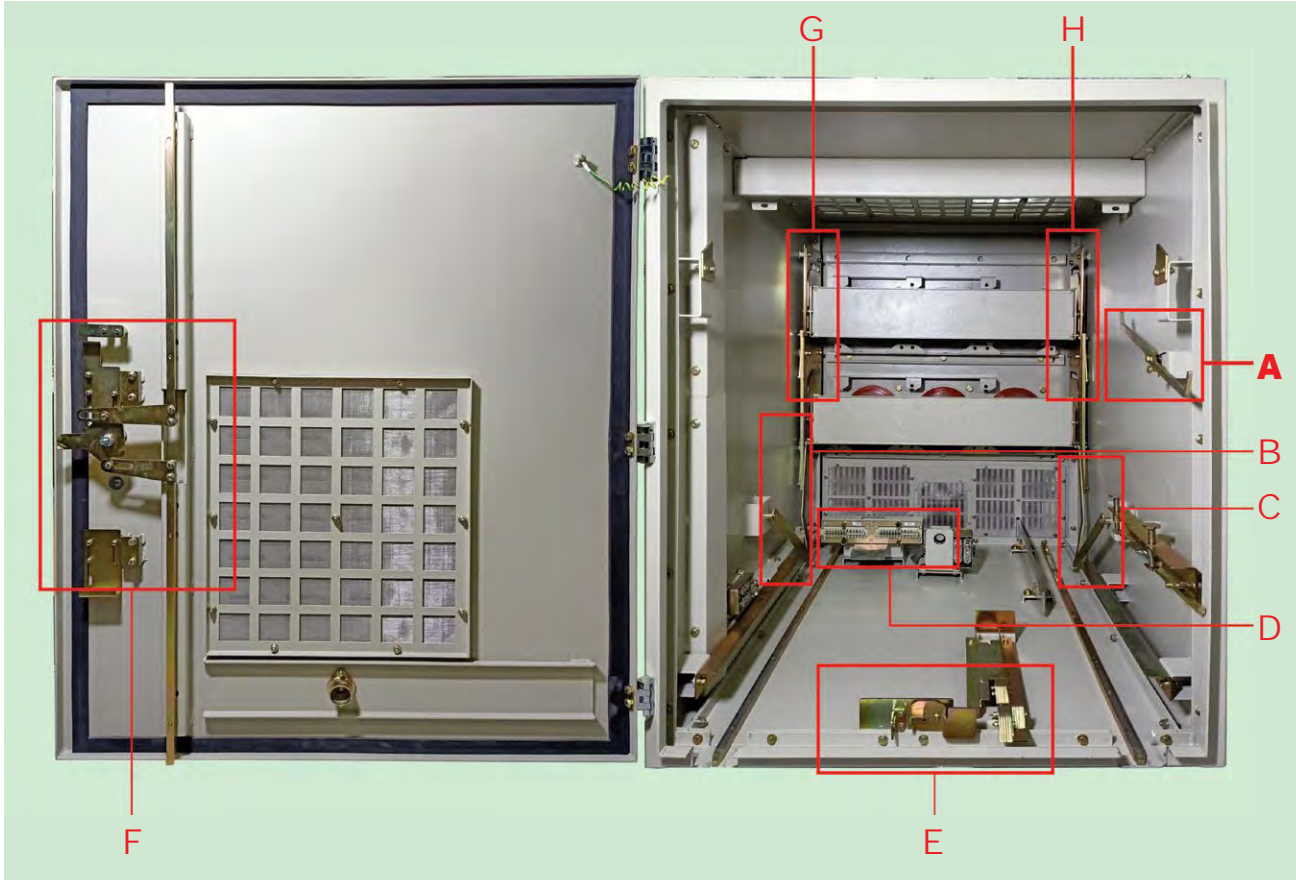

FIGURE 125

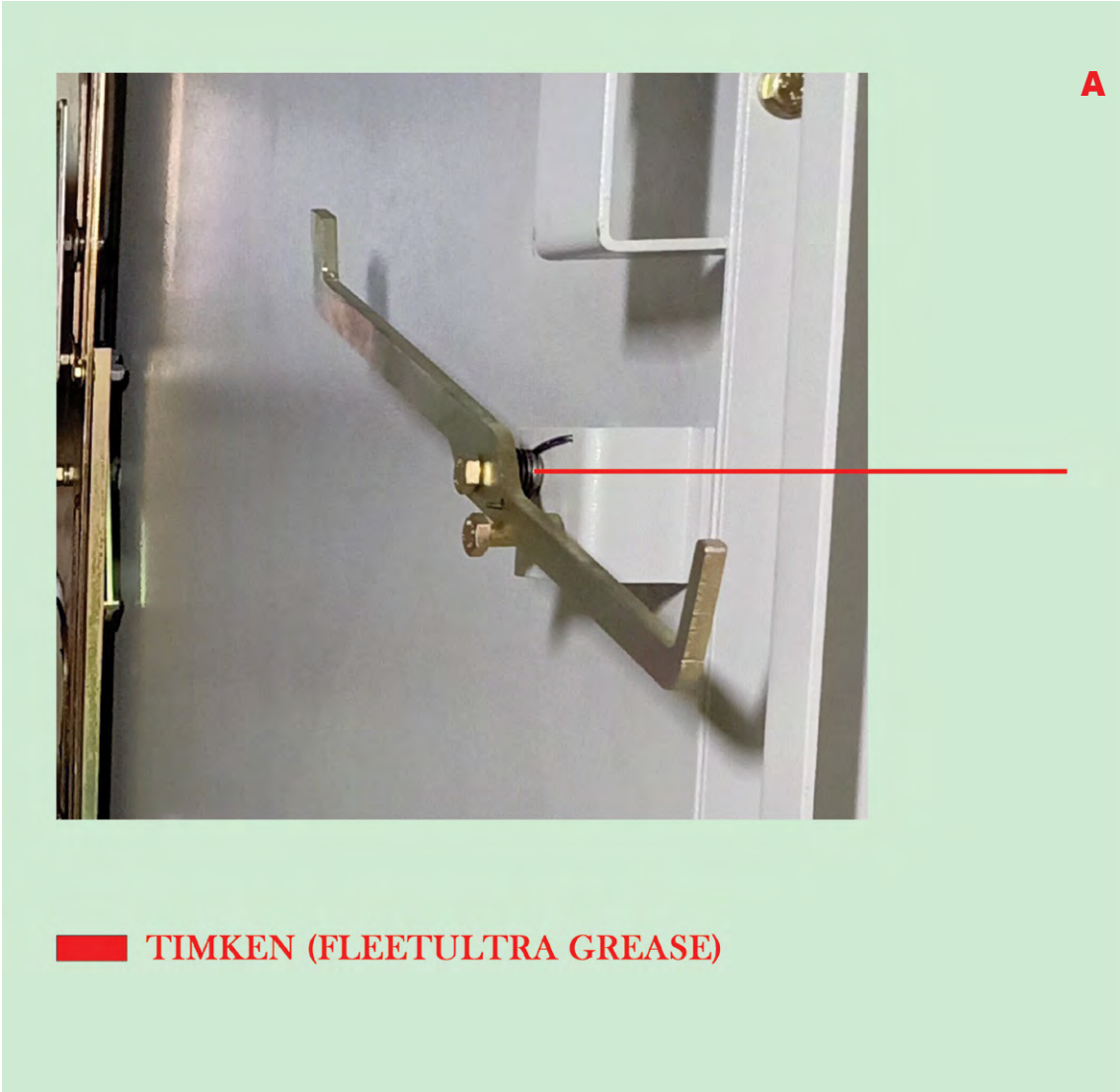
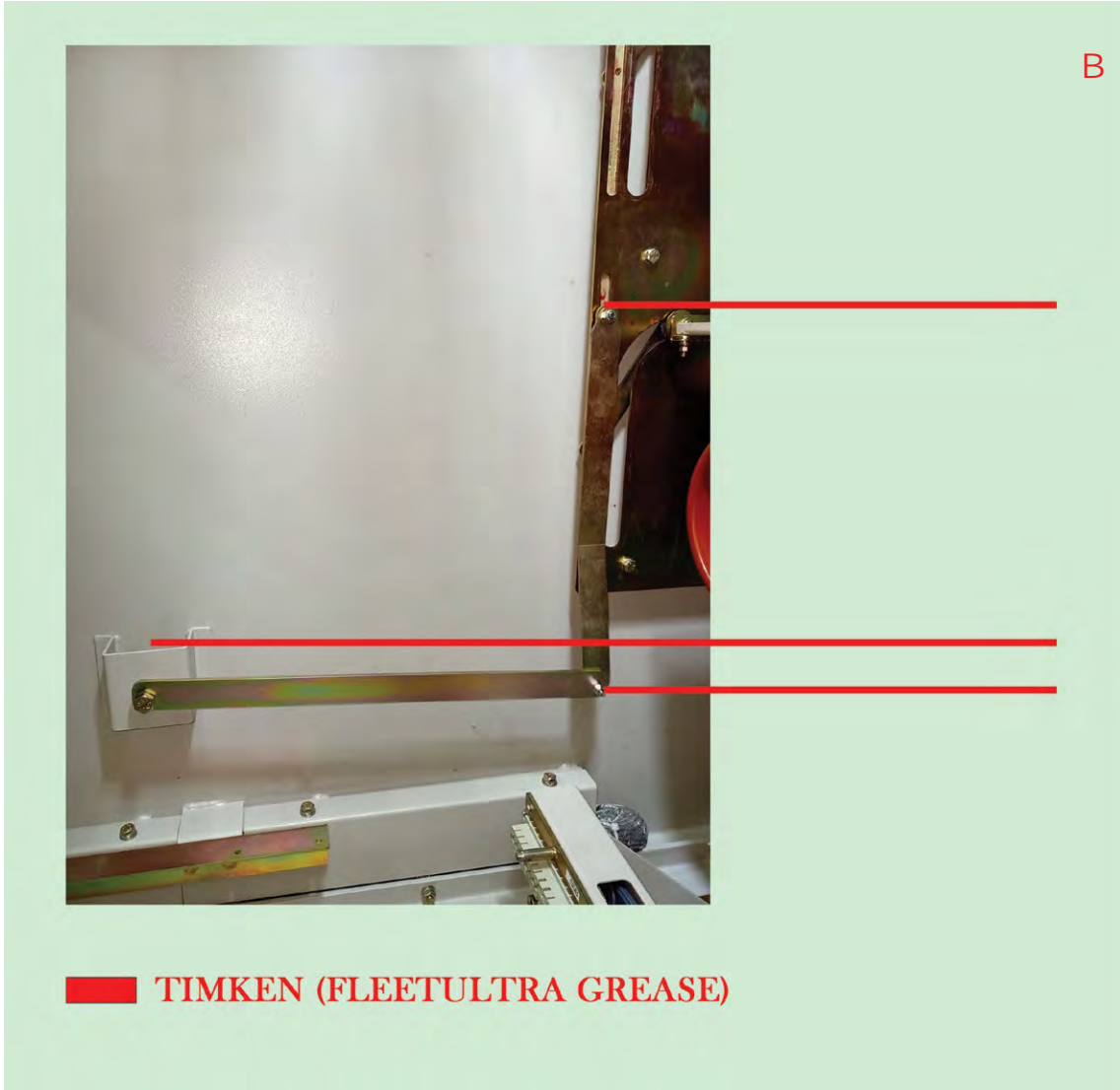
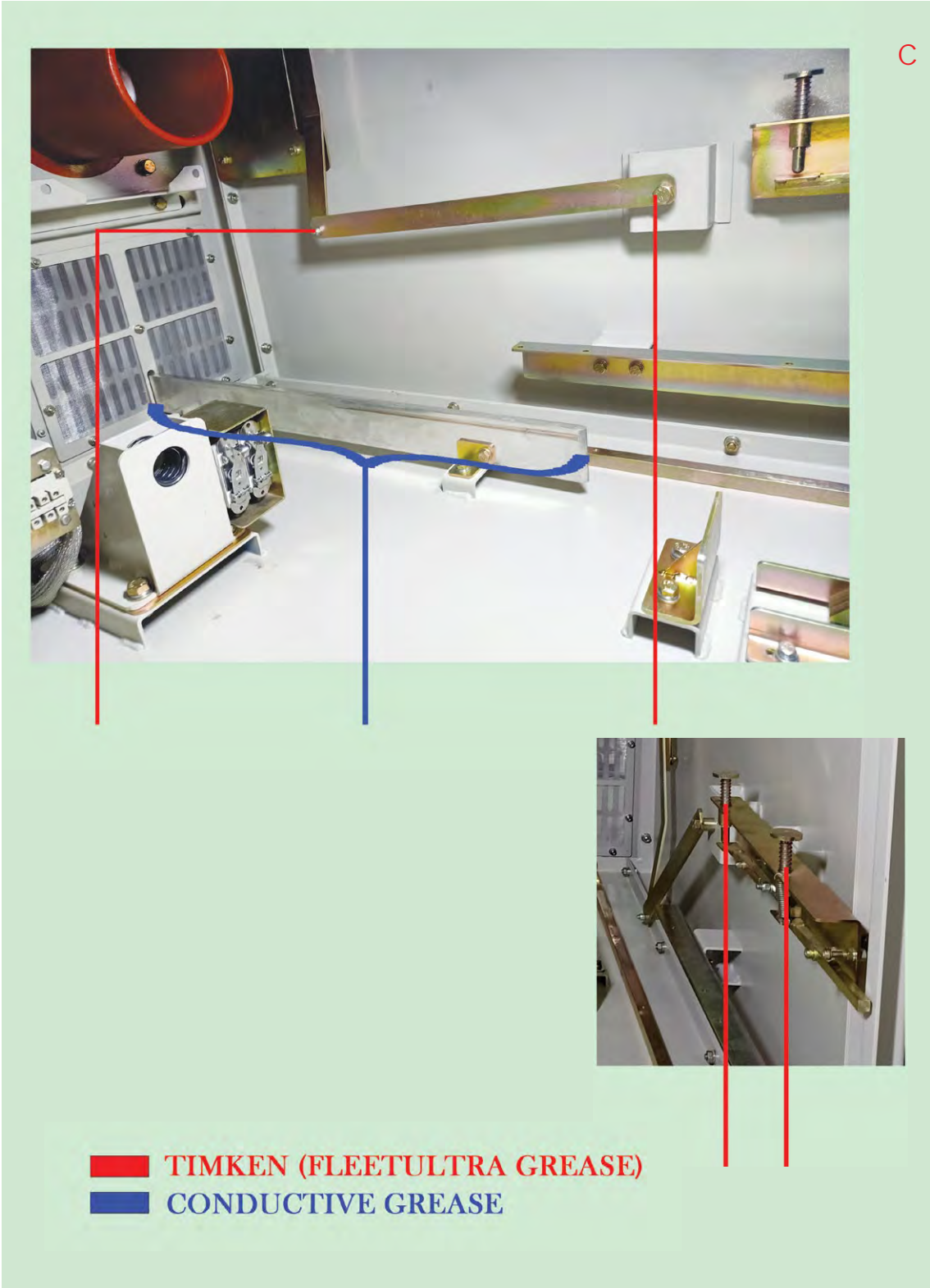

FIGURE 126



LUBRICATION

FIGURE 127



LUBRICATION

FIGURE 128

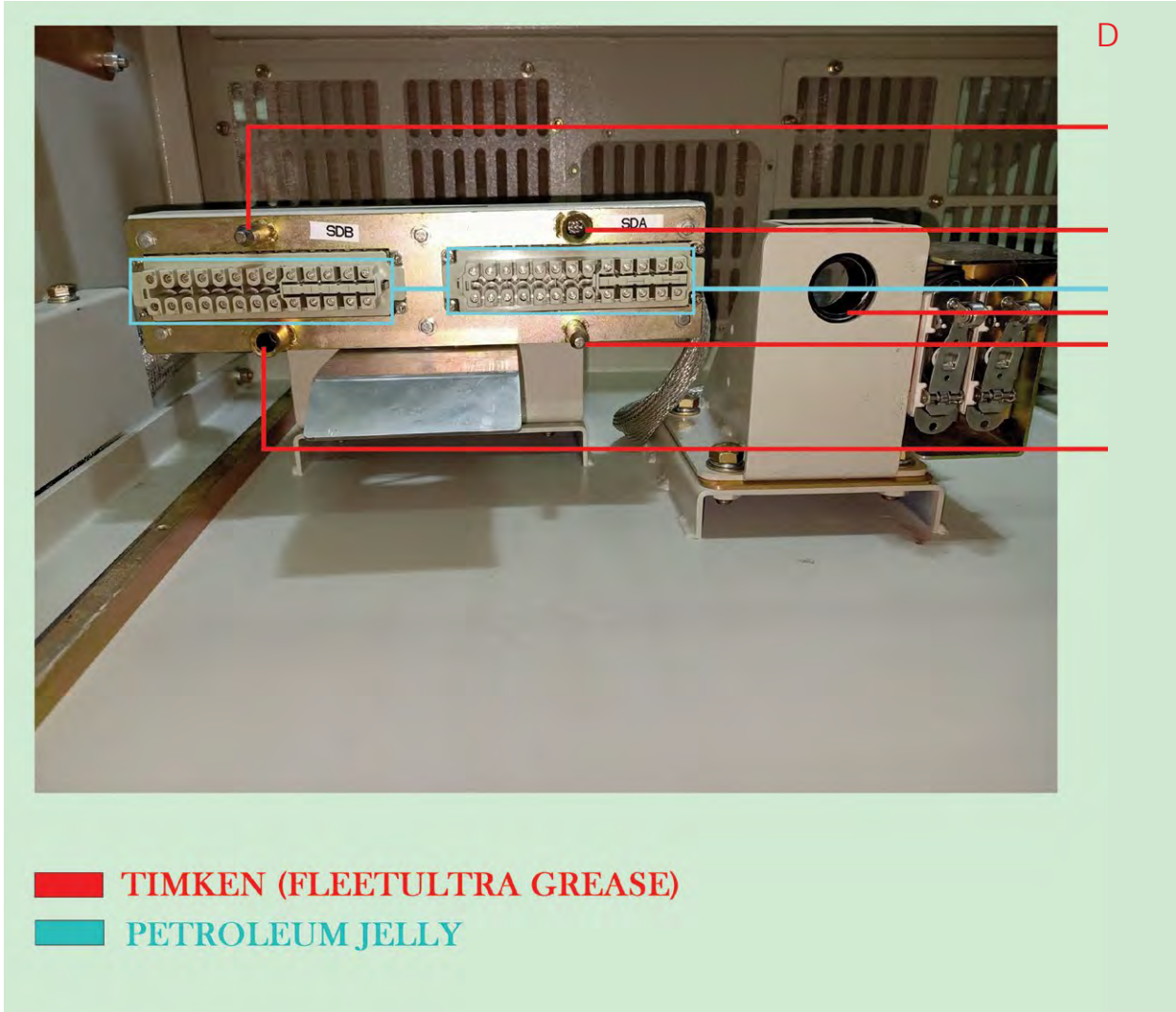

LUBRICATION

FIGURE 129

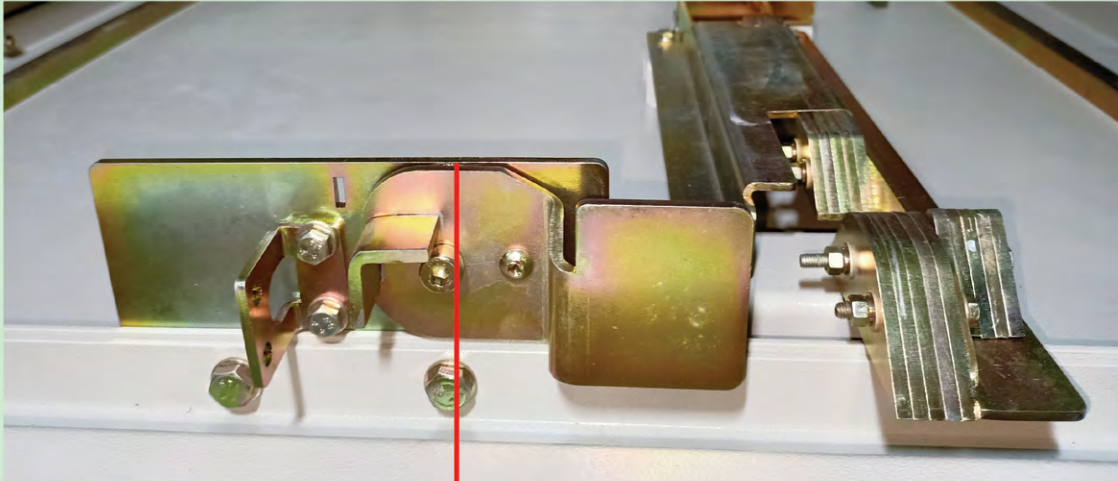

E

■ TIMKEN (FLEETULTRA GREASE)

LUBRICATION

FIGURE 130

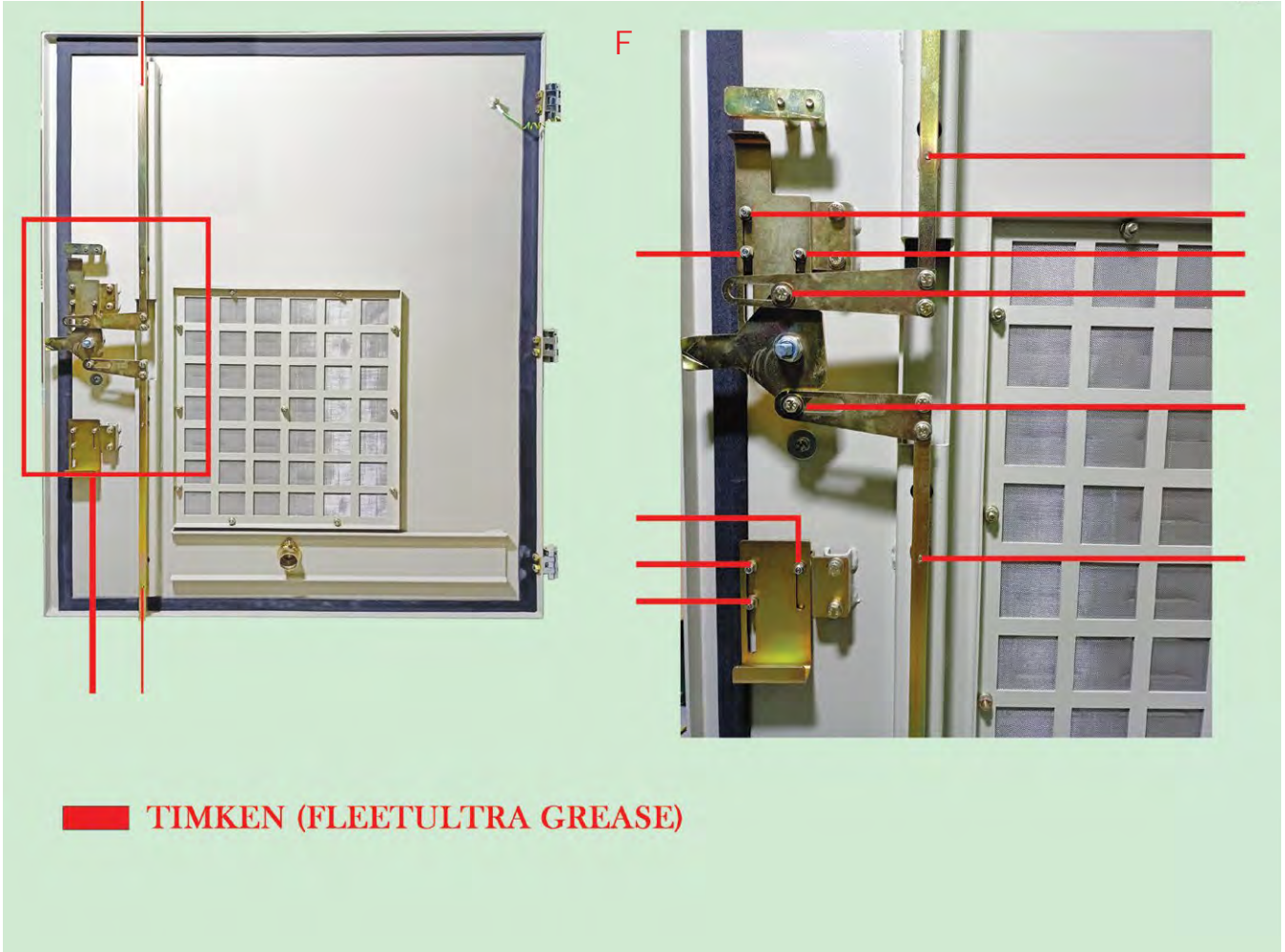

SEQUENTIAL OPERATION DIAGRAM

FIGURE 131 - OPERATOR SEQUENTIAL OPERATION DIAGRAM

Closing

To avoid a continuously applied closing command causing the circuit breaker to reclose automatically after it has tripped out on a fault as well as damaging the close coil – the Citadel breaker has a relay in the closing circuit known as an “Anti-Pumping” relay. (ANSI # 52 Y).

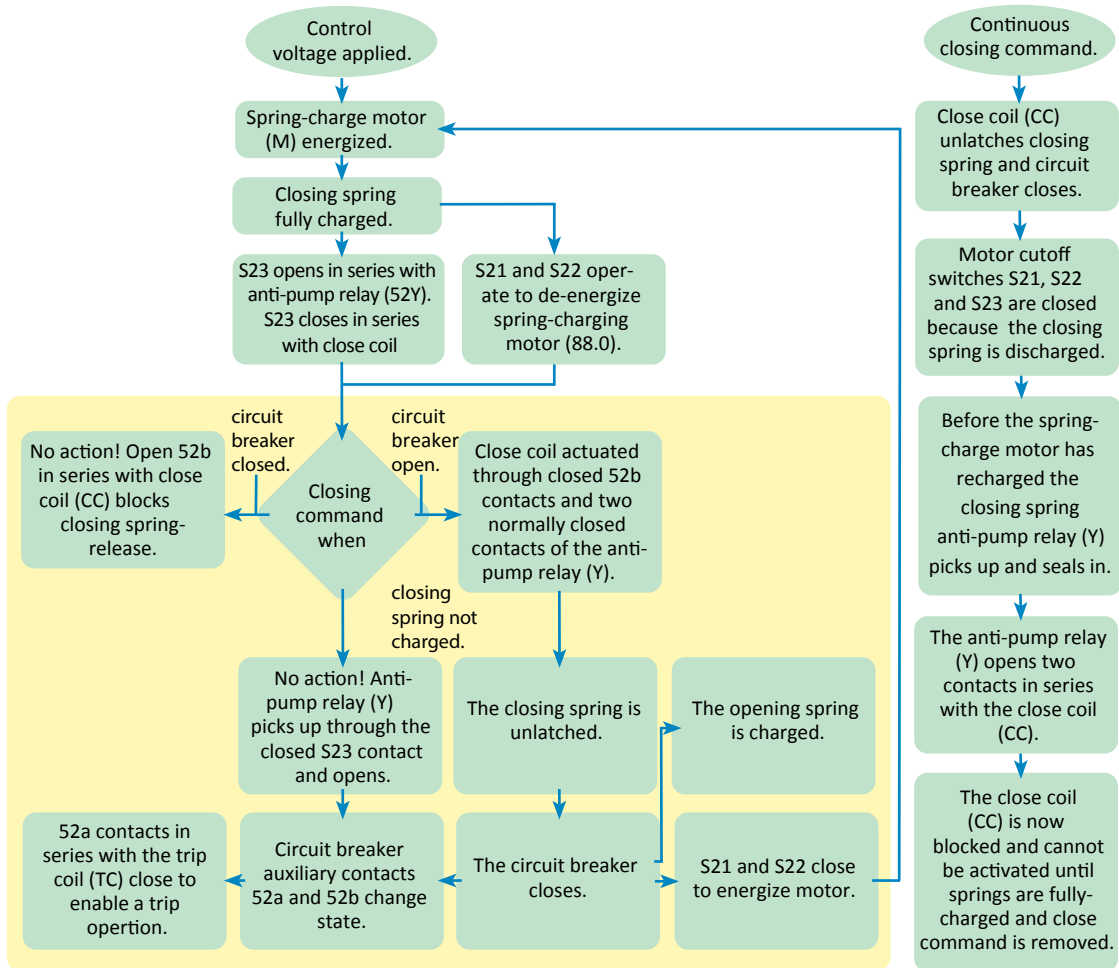

As long as there is control power on the breaker - the Citadel closing spring will automatically charge / recharge. Operating (releasing) the Close Spring closes the circuit breaker which at the same time imparts energy into charging the Tripping Spring. Therefore, when the circuit breaker is electrically connected to control power and is closed; both its Close and Trip Springs are charged. This condition allows the circuit breaker to be capable of Opening and then rapidly performing a Close – Open operation. After three (3) minutes the breaker can again perform a Close – Open operating cycle.

Tripping

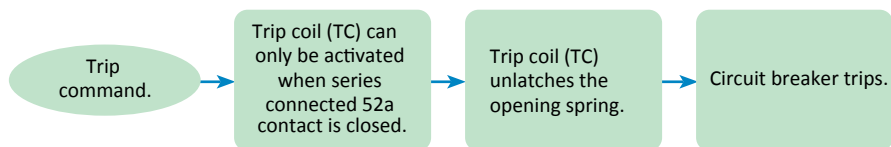
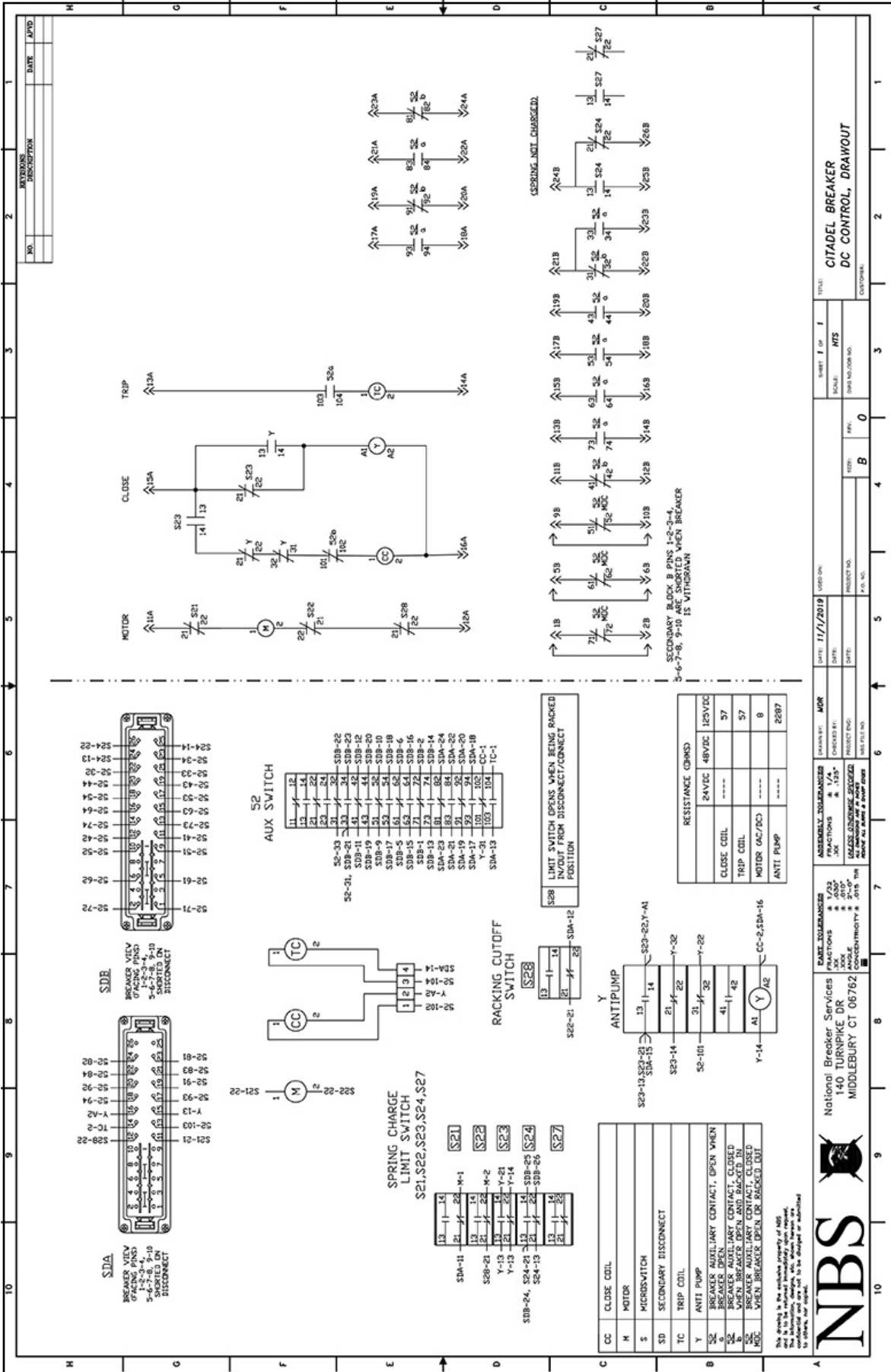

TABLE 20 - TROUBLESHOOTING GUIDE

Symptom	Cause	Action
Breaker will not charge	Motor switch off	Check Cable of Motor Line
	No control power	Breaker in Disconnect Position
	Motor will not run	Replace the Motor
	Spring charged	Check the Spring Charged Indicator
Breaker will not close	Closing spring not charged	Charge Closing Spring
	Breaker closed	Check the Position Indicator
	Breaker is not in proper position	Set into the Disconnect, Test, or Connect Position
	No electrical close signal	Verify Control Power Available Check Close Solenoid
Breaker will not open	Breaker open	Check the Position Indicator
	No electrical open signal	Verify Control Power Available Check the Open Solenoid

WIRING DIAGRAM



S P A R E P A R T S L I S T

WARNING

The use of unauthorized parts in the repair of the equipment, or tampering by unqualified personnel can result in hazardous conditions, that can result in death, serious injury or property damage.

WARNING

The use of unauthorized parts in the repair of the equipment, or tampering by unqualified personnel will void all warranties. Follow all safety instructions contained herein.

- **Vacuum Interrupters**
- **Charging motor**
- **Auxiliary switch**
- **Opening / Closing (coil) solenoid**
- **Anti-Pump Contactor**
- **Bridge Rectifier**
- **Operations Counter**
- **Red Push Button**
- **Green Push Button**
- **Epoxy molded VI housing**
- **Push Rod Assembly**
- **Front Panel (blank)**
- **Front Panel (silk Screened)**
- **Indication escutcheon panel (blank)**
- **Indication escutcheon panel (silk screened)**

1600A Vacuum Interruptor



2500A Vacuum Interruptor



4000A Vacuum Interruptor



5000A Vacuum Interruptor



Charging Motor

48V DC - 120VAC/DC - 240 VAC/DC



Auxiliary switch

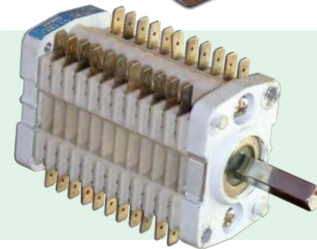

Opening / Closing (coil) solenoid

48V DC - 120VAC/DC - 240 VAC/DC



SPARE PARTS LIST

Anti-Pump Contactor
Specify control voltage



Bridge Rectifier
Specify control voltage



Operations Counter



Red Push Button



Green Push Button



Epoxy molded VI housing



Push Rod Assembly



Push Rod Assembly



SPARE PARTS LIST

Front Panel (blank)



Front Panel (silk Screened)

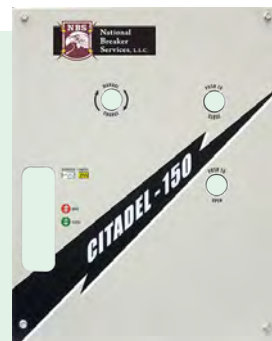

Indication escutcheon panel (blank)



Indication escutcheon panel (silk screened)



Gear box



Micro Switches



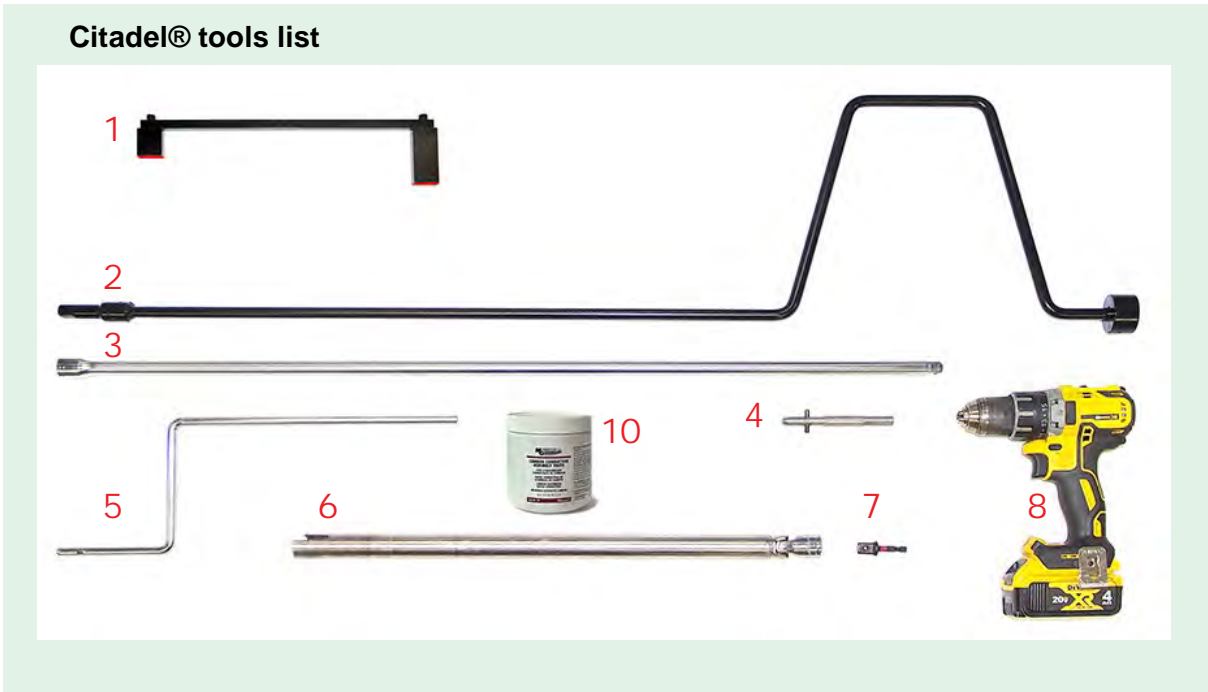

1. Vacuum interrupter wipe gauge
2. Racking tool manual operation handle
3. Racking tool extension rod
4. Close spring charging tool for semi-autonomous application
5. Manual spring charge handle
6. Racking tool
7. Racking tool adapter for semi-autonomous application
8. Semi-autonomous torque generator
9. Recommended mechanism lubricant
10. Recommended conducting lubricant:
 MG Chemicals - Carbon Conductive Assembly Paste
11. Remote racking device (see product specification page)

Field Services

NBS can provide factory-trained field service representatives to provide technical guidance and advisory assistance for the installation, overhaul, repair and maintenance of our equipment.

Contact NBS at: (203) 756-2524

Ask for service Dept. or Info@nationalbreaker.com

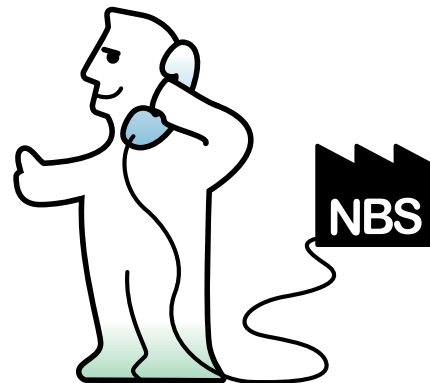

National Breaker Services, L.L.C.

Trademarks mentioned in this document are the property of National Breaker Services, L.L.C.

Subject to change without prior notice.

The information in this document contains general descriptions of the technical options available, which may not apply in all cases.

The required technical options should therefore be specified in the contract.

Contact

Phone: (203) 756-2524

x304 / x321 - technical sales

Toll Free: (800) 806-5552 | 888-CITADEL (888-824-8233)

Fax: (203) 756-2530

sales@nationalbreaker.com

140 Turnpike Drive Middlebury CT 06762 US